



# Information technologique: Possibilités & potentiels

# Patents: 80% technological information

- Titre de propriété industrielle qui confère à son titulaire un droit exclusif d'exploitation sur l'invention brevetée, durant une durée limitée (généralement 20 ans) et sur un territoire déterminé (en général un pays unique, et dans certains cas un groupe de pays).
- En contrepartie, l'invention doit être divulguée au public
- Les demandes de brevet sont automatiquement publiées 18 mois après la date de priorité, c'est-à-dire le premier dépôt.
- Obligatoirement décrit par la Classification Internationale des Brevets

<p>19</p>  <p>REPÚBLICA FEDERATIVA DO BRASIL Ministério da Justiça Instituto Nacional da Propriedade Industrial</p> <p><b>INPI</b> DOCUMENTO ORIGINAL BANCO DE PATENTES</p>	<p>11      21      <b>PI 8806232 A</b></p> <p>43      <b>Data da publicação: 24/07/90</b> (RPI 1025)</p> <p>61      <b>Int Cl<sup>4</sup>: E04H 15/06</b></p>
<p>30      <b>Prioridade unionista:</b></p> <p>71      <b>Depositante:</b> José Torres. (BR/SP)</p> <p>72      <b>Inventor(es):</b> José Torres. (BR/SP)</p> <p>74      <b>Procurador:</b></p>	<p>54      <b>Título:</b>                      57      <b>Resumo:</b></p> <p>“Baú-casa.”</p> <p>Patente de Invenção de um baú que se transforma em casa, compreende a composição de dois conjuntos, um fixo e outro móvel. O conjunto fixo através do acionamento das colunas de sustentação, suspende o tecto levantando simultaneamente as paredes laterais e posteriormente as demais paredes, ampliando ambos os conjuntos em sua altura original, liberando dessa maneira o conjunto móvel, que fica na posição para ser deslocado através de guias e fuso para a esquerda ampliando sua largura original.</p>

# Analyse statistique: base interne (20 000 brevets)

William Nivol 10 Mai 1993

- Doutorado Bolsista da Loreal
- Atualmente arjowiggins

<http://www.arjowiggins.com/>

- ◆ Réseaux d'inventeurs
- ◆ Politique d'extension, leaders
- ◆ Analyse d'un sujet



# Réseau d'inventeurs d'un concurrent

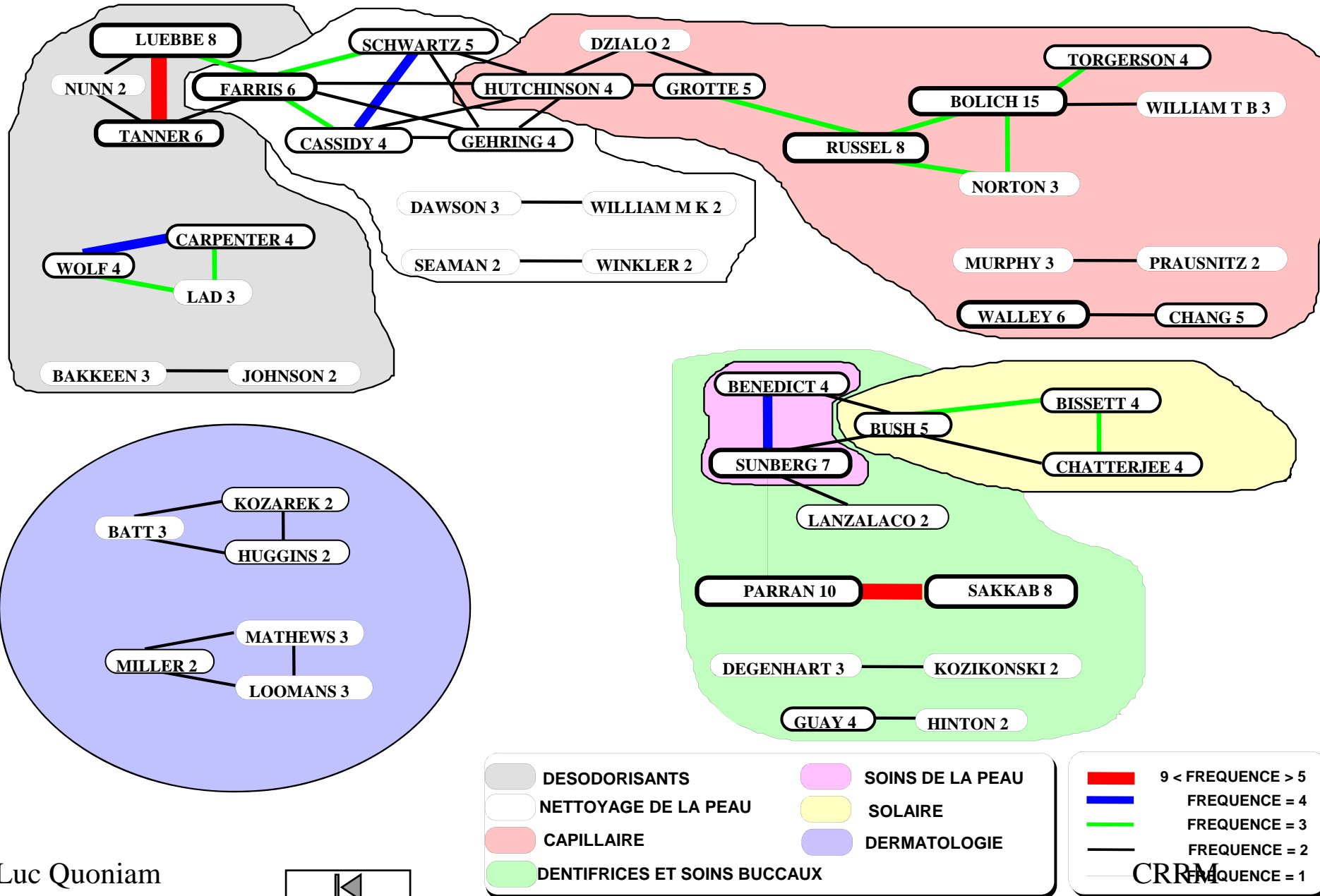

# Les spectres d'extension:

## Attitude des sociétés face au phénomène d'extension

	1	2	3	4	5	6	7	8	9	10	11	12	13	14	15	16	17	18	19	20	21	22	23	24	25	30	32	33	34	
AVON	4					1	1									2														
BRISTOL MYERS	14	6	1	2		1	1	1				3	3	10	4	4		1						1						
CIBA GEIGY	2	7	2	2	1		1	1		1	1	2	1	1	1	1	2	1		2	1									
COLGATE	20	6	2	3		1	2	4	2	3		2	5	7	2	5	5	9	1	3	1									
PFIZER	3	1			1							2	2		4	1	3	1	4	1	4	1	1	1	1	2				
L'OREAL	23	1		1						1	7	11	23	26	18	8	6	12	7	2										
HOECHST	12	5	3	4	6	4	3	7	6	4	1	3	2	1	4	5	3	2	1	2	3	3			1					
HOFFMAN												4	12	8	20	16	4	8	8	4	16									
HENKEL	9	7	4	16	10	13	20	19	14	13	15	17	40	42	29	9	6	1	1	3	3	1								
LION	390	11	5	2	1	1																								
GAF	19	2										2	1	11	13	2														
GILLETTE	6	2	1				1				1	2	2	3	3	3	3	2	2	1			1							
GOLDSCHMIDT		3					4	4	2		1																			
KAO	366	4	4	11	20	9	8	10	33	15	5	4	5																	
LVMH										1	2	1	4	2	2	4														
PROCTER	47	9	1								3	7	21	24	26	24	14	16	5	6	2	2								
SHISEIDO	754	3	3	2	5		3	4																						
UNILEVER	21	7	3	1	2		1	5	4		19	18	38	22	16	8		3	2											
UPJOHN																										4	4		3	
WARN. LAMBERT	8	5				1	1	2		1	5		1	1		1	1	2	5	8	2					1				
WELLA	36	4	2	1		4	1	4		3	5	6	5	10	9	2	4	2		1	1									

DEPOTS DE BREVETS PROCTER

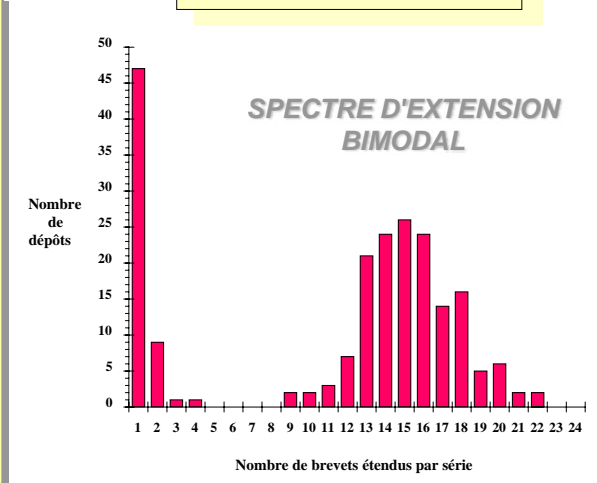

DEPOTS DE BREVETS HOFFMAN

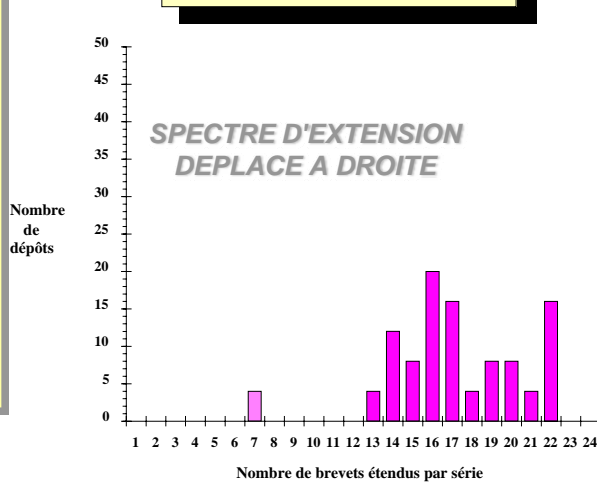

# Les leaders par dépôts de séries de 1982 à 1989

(en part de marché)

R  
A  
N  
G

1982

1983

1984

1985

1986

1987

1988

1989

1	SHISEIDO 22	LION 21	SHISEIDO 19	SHISEIDO 36	SHISEIDO 22	SHISEIDO 19	SHISEIDO 17	KAO 16
2	LION 21	SHISEIDO 19	LION 18	KANEBO 12	KANEBO 15	LION 15	KAO 14	KANEBO 13
3	L'OREAL 8	KAO 9	KAO 12	KAO 12	LION 14	KANEBO 12	KANEBO 12	SHISEIDO 11
4	PROCTER 7	L'OREAL 8	KANEBO 11	LION 9	KAO 12	KAO 12	L'OREAL 11	LION 9
5	HENKEL 6	HENKEL 6	L'OREAL 8	PROCTER 5	L'OREAL 7	L'OREAL 8	LION 10	L'OREAL 8



# Rechercher ou acheter ?

## LES POLYMERES CATIONIQUES NATURELS

CHITOSANE

149

CELLULOSE

108

GUAR

33

AMIDON

16

PROTEINE

24

DIVERS	63	LION	22	PROCTER	11	KAO	6	SEIWA KASEI	6
WELLA	18	DIVERS	18	UNILEVER	9	LION	6	DIVERS	4
LION	14	KAO	9	DIVERS	6	DIVERS	2	LION	3
KAO	7	PROCTER	9	DEGUSSA	2	NIPPON OILS	1	L'OREAL	2
AJINOMOTO	6	L'OREAL	7	WELLA	2	SEIWA KASEI	1	UNILEVER	2
DAICEL	5	UNILEVER	6	BEECHAM	1			COLGATE	1

# Matrice de réflexion

## LES POLYMERES CATIONIQUES

MATRICE DE COOCCURENCES

(Types d'application + Propriétés) x Familles chimiques

TYPES  
D'APPLICATION



CORPUS (564 doc)

SHAMPOOING

COLORATION

PERMANENTE

ANTISOLAIRE

DECREPAGE

PROPRIETES



CONDITIONNEMENT

DOUCEUR

EFFET COIFFANT

HYDRATATION

PROTECTION

POUVOIR DEMELANT

	A	B	C	D	E	F	G	H	I	TOTAL
CORPUS (564 doc)	56	36	26	19	6	4	16	10	11	564
SHAMPOOING	56	30	14	27	10	10	16	10	6	125
COLORATION	57	34	21	28	0	9	19	15	9	47
PERMANENTE	53	40	16	35	2	9	21	14	19	43
ANTISOLAIRE	68	24	36	16	12	8	12	12	0	25
DECREPAGE	38	77	0	23	8	15	46	8	23	13
CONDITIONNEMENT	47	45	8	25	9	9	19	14	14	138
DOUCEUR	49	46	15	20	5	14	19	4	16	74
EFFET COIFFANT	50	45	19	17	9	7	9	16	26	58
HYDRATATION	87	17	43	20	9	13	7	2	0	54
PROTECTION	67	27	31	22	6	12	10	10	6	51
POUVOIR DEMELANT	37	63	7	19	7	7	26	11	22	27

A POLYMERES NATURELS  
B POLYMERES SYNTHETIQUES  
C CHITOSANE  
D CELLULOSE

E GUAR  
F PROTEINES  
G CYCLOPOLYMERES  
H RADICALAIRES QUATERNAIRES

I RADICALAIRES AMINES

VALEURS NETTEMENT SUPERIEURES / MOYENNE VALEURS NETTEMENT INFERIEURES / MOYENNE

Les chiffres représentent des % de séries / au total ligne



# Relation: Science-Technologie: mythe ou réalité?

## ◆ Raimundo Nonato das Santos 06/07/1995

- Ingénieur IPT, Bolsista CNPq
- Professor PUC Campinas

<http://buscatextual.cnpq.br/buscatextual/visualizacv.jsp?id=K4793933Y1>

## ◆ Pascal Faucompré 13/10/1997

- Ingénieur Sciençia da Informação

Lien Science-Technologie

# Quel type de rapport ??

**TRAVAIL FONDAMENTAL**



**LABORATOIRE  
DE BIOLOGIE**



**OBJET TECHNIQUE**

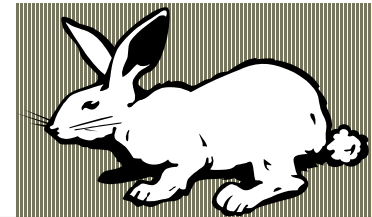

**FABRICANT  
DE CLAPIERS  
A LAPINS**

→ **Client-expert ?**

→ **Fournisseur ?**

→ **Marché ?**

# Indexation d'une référence scientifique

AN 34/1949 - (C) CNRS

ET Specificity of anti-P25 antibodies produced against whole HIV-1 particles or soluble forms of the protein

AU KAMEL MABROUK; ABDELAZIZ BENJOUAD; GLUCKMAN J C; ROCHAT H; VAN RIETSCHOTEN J; ELMOSTAFA BAHRAOUI

AF CNRS Fac. medecine Nord, lab. biochimie/13326 Marseille/FRA; CNRS Hop. Pitie-Salpetriere, lab. biologie genetique pathologies immunitaires/75651 Paris/FRA

DT Periodique; LA

SO Molecular immunology; ISSN 0161-5890; Coden MOIMD5; GBR; DA. 1992; VOL. 29; NO. 11 ; PP. 1309-1318; BIBL. 1 p. 1/2

LA ENG

EA Specificity of anti-p25 antibodies produced against either whole Human Immunodeficiency Virus type 1 (HIV-1) particles in humans and chimpanzees, or against soluble forms of the protein in chimpanzees and rabbits was analyzed by ELISA using a panel of 37 long (30 residues) or shorter (9-21 residues) overlapping peptides covering the entire p25 sequence. Antibodies elicited by intact virions presented similar reactivity patterns in HIV-1-infected humans and in HIV-1-infected or immunized chimpanzees and recognized only a limited region mostly the C-terminus of the molecule

CC 002A06C05C

**FD Lapin; Virus HIV1; Antigene; Particule core; Peptide; Specificite; Anticorps; Homme; Antigenicite; Immunogenicite; Sequence aminoacide**

**ED Rabbit; HIV-1 virus; Antigen; Core particle; Peptides; Specificity; Antibody; Human; Antigenicity; Immunogenicity; Aminoacid sequence**

FG Lagomorpha; Mammalia; Vertebrata; Virus immunodeficiency humaine; Lentivirinae; Retroviridae; Virus

LO INIST-12239.354000032022160030

*indexation  
contrôlée*

# Indexation d'une référence technique

BREF 1994/06

Recherche Multicritères

I.N.P.I. 30/09/1997

1/32 FR2701417 1994 08 19

PUB : FR2701417 1994 08 19  
NDP : FR9301660 1993 02 15  
CIB : B24D-013/18  
CIB2: B24D-013/20  
DEP : CIFAP SA  
INV : VEZIER JACQUES  
TIT : Outil abrasif rotatif comportant des moyens de refroidissement.  
RES : La présente invention concerne un outil abrasif rotatif, du type comprenant un premier élément constitué par un support (1) discoïde rigide muni de moyens pour le couplage à un moteur d'entraînement, et par un deuxième élément formé par un disque (2) amovible comportant une surface abrasive formée par l'inclusion de matériaux abrasifs dans une résine de liaison, et une surface de liaison présentant des moyens de coopération avec le support (1) discoïde, la solidarisation entre les deux éléments étant réalisée par des



ACCES CONTROLE PAR CODES DE CLASSEMENT

*pas de champ d'indexation*

The image shows a technical drawing of a rotating abrasive tool. A blue arrow points from the 'CIB' classification codes to the drawing. A red arrow points from the 'RES' text to a red box containing the text 'pas de champ d'indexation'. A blue box contains the text 'ACCES CONTROLE PAR CODES DE CLASSEMENT'.

# Vers une référence hybride ??

**AN 34/1949 - (C) CNRS**

**ET Specificity of anti-P25 antibodies produced against whole HIV-1 particles or soluble forms of the protein**

**AU KAMEL MABROUK; ABDELAZIZ BENJOUAD; GLUCKMAN J C; ROCHAT H; VAN RIETSCHOTEN J; ELMOSTAFA BAHRAOUI**

**AF CNRS Fac. medecine Nord, lab. biochimie/13326 Marseille/FRA; CNRS Hop. Pitie-Salpetriere, lab. biologie genetique pathologies immunitaires/75651 Paris/FRA**

**DT Periodique; LA**

**SO Molecular immunology; ISSN 0161-5890; Coden MOIMD5; GBR; DA. 1992; VOL. 29; NO. 11 ; PP. 1309-1318; BIBL. 1 p. 1/2**

**LA ENG**

**EA Specificity of anti-p25 antibodies produced against either whole Human Immunodeficiency Virus type 1 (HIV-1) particles in humans and chimpanzees, or against soluble forms of the protein in chimpanzees and rabbits was analyzed by ELISA using a panel of 37 long (30 residues) or shorter (9-21 residues) overlapping peptides covering the entire p25 sequence. Antibodies elicited by intact virions presented similar reactivity patterns in HIV-1-infected humans and in HIV-1-infected or immunized chimpanzees and recognized only a limited region mostly the C-terminus of the molecule**

**CC 002A06C05C**

**IC C07K-000/00; A01K-001/02**

**FD Lapin; Virus HIV1; Antigene; Particule core; Peptide; Specificite; Anticorps; Homme; Antigenicite; Immunogenicite; Sequence aminoacide**

**ED Rabbit; HIV-1 virus; Antigen; Core particle; Peptides; Specificity; Antibody; Human; Antigenicity; Immunogenicity; Aminoacid sequence**

**FG Lagomorpha; Mammalia; Vertebrata; Virus immunodeficiency humaine; Lentivirinae; Retroviridae; Virus**

**LO INIST-12239.354000032022160030**

# Correspondance directe

## 1 ARTICLE SCIENTIFIQUE

AN 34/1949 - (C) CNRS  
ET Specificity of anti-P25 antibodies produced against whole HIV-1 particles or soluble forms of the protein  
AU KAMEL MABROUK; ABDELAZIZ BENJOUAD; GLUCKMAN J C; ROCHAT H; VAN RIETSCHOTEN J; ELMOSTAFA BAHRAOUI  
AF CNRS Fac. medecine Nord, lab. biochimie/13326 Marseille/FRA; CNRS Hop. Pitie-Salpetriere, lab. biologie genetique pathologies immunitaires/75651 Paris/FRA  
DT Periodique; LA  
SO Molecular immunology; ISSN 0161-5890; Coden MOIMD5; GBR; DA. 1992; VOL. 29; NO. 11 ; PP. 1309-1318; BIBL. 1 p. 1/2  
LA ENG  
EA Specificity of anti-p25 antibodies produced against either whole Human Immunodeficiency Virus type 1 (HIV-1) particles in humans and chimpanzees, or against soluble forms of the protein in chimpanzees and rabbits was analyzed by ELISA using a panel of 37 long (30 residues) or shorter (9-21 residues) overlapping peptides covering the entire p25 sequence. Antibodies elicited by intact virions presented similar reactivity patterns in HIV-1-infected humans and in HIV-1-infected or immunized chimpanzees and recognized only a limited region mostly the C-terminus of the molecule  
CC 002A06C05C  
FD Lapin; Virus HIV1; Antigene; Particule core; Peptide; Specificite; Anticorps; Homme; Antigenicite; Immunogenicite; Sequence aminoacide  
ED Rabbit; HIV-1 virus; Antigen; Core particle; Peptides; Specificity; Antibody; Human; Antigenicity; Immunogenicity; Aminoacid sequence  
FG Lagomorpha; Mammalia; Vertebrata; Virus immunodeficiency humaine; Lentivirinae; Retroviridae; Virus  
LO INIST-12239.354000032022160030

## 1 DOCUMENT DE BREVET

*Code CIB x*

IC- C12N001/20, C12P005/02

AU- Marty D G et al

TI- Isolement de deux souches méthanogènes thermophiles appartenant au genre Methanobacterium

JO- Comptes-rendus des Séances de l'Académie des Sciences

JN- Compt. Acad. Sci. Fr.

LA- Fr

YR- 1981

VO- 292

IS- 3,1

PG- 41 - 43



***non réalisable  
non souhaitable***

# Réindexation humaine

⇒ UNE METHODE MANUELLE ?



*une solution  
automatique*

*< 1 MF  
qq semaines*

# Un lien automatique

## PUBLICATIONS SCIENTIFIQUES

AN 34/1949 - (C) CNRS  
ET Specificity of anti-P25 antibodies produced against whole HIV-1 particles or soluble forms of the protein  
AU KAMEL MABROUK; ABDELAZIZ BENJOUAD; GLUCKMAN J C; ROCHAT H; VAN RIETSCHOTEN J; ELMOSTAFA BAHRAOUI  
AF CNRS Fac. medecine Nord, lab. biochimie/13326 Marseille/FRA; CNRS Hop. Pitié-Salpêtrière, lab. biologie genetique pathologies immunitaires/75651 Paris/FRA  
DT Periodique; LA  
SO Molecular immunology; ISSN 0161-5890; Coden MOIMD5; GBR; DA. 1992; VOL. 29; NO. 11; PP. 1309-1318; BIBL. 1 p. 1/2  
LA ENG  
EA Specificity of anti-p25 antibodies produced against either whole Human Immunodeficiency Virus type 1 (HIV-1) particles in humans and chimpanzees, or against soluble forms of the protein in chimpanzees and rabbits was analyzed by ELISA using a panel of 37 long (30 residues) or shorter (9-21 residues) overlapping peptides covering the entire p25 sequence. Antibodies elicited by intact virions presented similar reactivity patterns in HIV-1-infected humans and in HIV-1-infected or immunized chimpanzees and recognized only a limited region mostly the C-terminus of the molecule  
CC 002A06C05C

## DOCUMENTS DE BREVET

IC- C12N001/20, C12P005/02  
AU- Marty D G et al  
TI- Isolation de deux souches méthanogènes thermophiles appartenant au genre Methanobacterium  
JO- Comptes-rendus des Séances de l'Académie des Sciences  
JN- Compt. Acad. Sci. Fr.  
LA- Fr  
YR- 1981  
VO- 292  
IS- 3.1  
PG- 41 -43

**OUTIL  
DE LIEN**

**REFERENCE LIEE**

AN 34/1949 - (C) CNRS  
ET Specificity of anti-P25 antibodies produced against whole HIV-1 particles or soluble forms of the protein  
AU KAMEL MABROUK; ABDELAZIZ BENJOUAD; GLUCKMAN J C; ROCHAT H; VAN RIETSCHOTEN J; ELMOSTAFA BAHRAOUI  
AF CNRS Fac. medecine Nord, lab. biochimie/13326 Marseille/FRA; CNRS Hop. Pitié-Salpêtrière, lab. biologie genetique pathologies immunitaires/75651 Paris/FRA  
DT Periodique; LA  
SO Molecular immunology; ISSN 0161-5890; Coden MOIMD5; GBR; DA. 1992; VOL. 29; NO. 11; PP. 1309-1318; BIBL. 1 p. 1/2  
LA ENG  
EA Specificity of anti-p25 antibodies produced against either whole Human Immunodeficiency Virus type 1 (HIV-1) particles in humans and chimpanzees, or against soluble forms of the protein in chimpanzees and rabbits was analyzed by ELISA using a panel of 37 long (30 residues) or shorter (9-21 residues) overlapping peptides covering the entire p25 sequence. Antibodies elicited by intact virions presented similar reactivity patterns in HIV-1-infected humans and in HIV-1-infected or immunized chimpanzees and recognized only a limited region mostly the C-terminus of the molecule  
CC 002A06C05C  
IC **C07K-000/00; A01K-001/02**  
FD Lapin; Virus HIV1; Antigene; Particule core; Peptide; Specificite; Anticorps; Homme; Antigenicite; Immunogenicite; Sequence aminoacide  
ED Rabbit; HIV-1 virus; Antigen; Core particle; Peptides; Specificity; Antibody; Human; Antigenicity; Immunogenicity; Aminoacid sequence  
FG Lagonorpha; Mammalia; Vertebrata; Virus immunodeficiency humaine; Lentivirinae; Retroviridae; Virus

# Réalisme informatique



**REFERENCES**

+ 25 Millions / an  
~ 300-400 M / BD

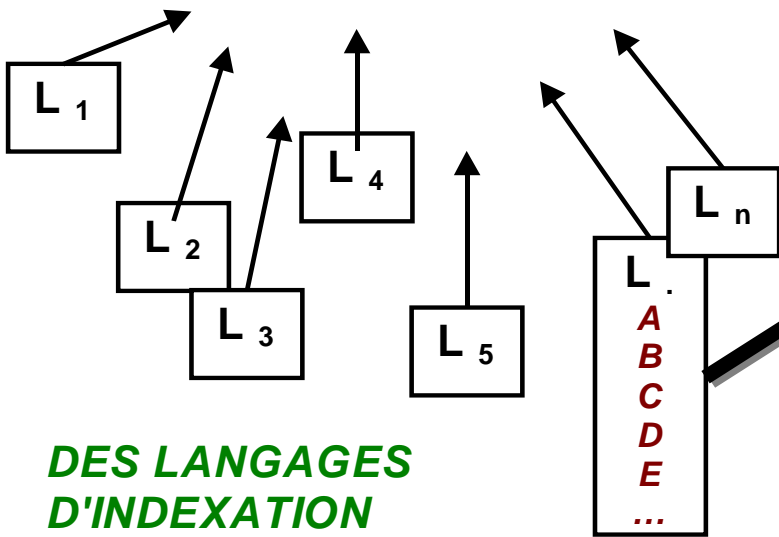

**DES LANGAGES  
D'INDEXATION**



**BREVETS**

+ 1 Million / an  
~ 32-37 M / BD

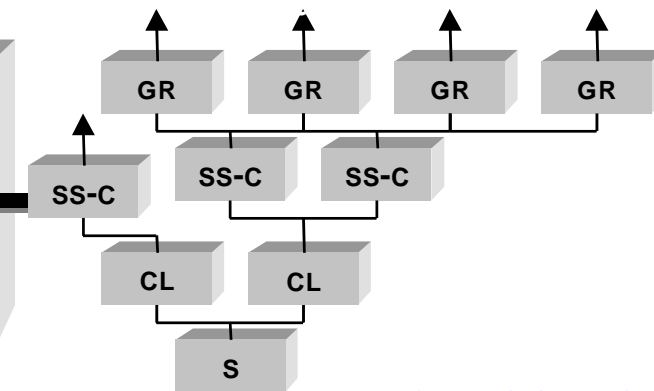
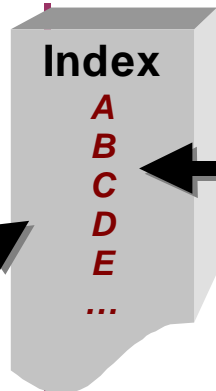

**LA CLASSIFICATION  
INTERNATIONALE  
DES BREVETS**

⇒ ACCEDER AUX  
REFERENCES ?

**LA MISE EN CORRESPONDANCE - DES OPTIONS BASSES**

# Descripteurs ou langage d'indexation?

⇒ UN LANGAGE D'INDEXATION ?

## REFERENCE BIBLIOGRAPHIQUE D'UNE PUBLICATION SCIENTIFIQUE

AN 34/1949 - (C) CNRS  
ET Specificity of anti-P25 antibodies produced against whole HIV-1 particles or soluble forms of the protein  
AU KAMEL MABROUK; ABDELAZIZ BENJOUAD; GLUCKMAN J C; ROCHAT H; VAN RIETSCHOTEN J; ELMOSTAFA BAHRAOUI  
AF CNRS Fac. medecine Nord, lab. biochimie/13326 Marseille/FRA; CNRS Hop. Pitie-Salpetriere, lab. biologie genetique pathologies immunitaires/75651 Paris/FRA  
DT Periodique; LA  
SO Molecular immunology; ISSN 0161-5890; Coden MOIMD5; GBR; DA. 1992; VOL. 29; NO. 11; PP. 1309-1318; BIBL. 1 p. 1/2  
LA ENG  
EA Specificity of anti-p25 antibodies produced against either whole Human Immunodeficiency Virus type 1 (HIV-1) particles in humans and chimpanzees, or against soluble forms of the protein in chimpanzees and rabbits was analyzed by ELISA using a panel of 37 long (30 residues) or shorter (9-21 residues) overlapping peptides covering the entire p25 sequence. Antibodies elicited by intact virions presented similar reactivity patterns in HIV-1-infected humans and in HIV-1-infected or immunized chimpanzees and recognized only a limited region mostly the C-terminus of the molecule  
CC 002A06C05C  
**FD Lapin; Virus HIV1; Antigene; Particule core; Peptide; Specificite; Anticorps; Homme; Antigenicite; Immunogenicite; Sequence aminoacide**  
ED Rabbit; HIV-1 virus; Antigen; Core particle; Peptides; Specificity; Antibody; Human; Antigenicity; Immunogenicity; Aminoacid sequence  
FG Lagomorpha; Mammalia; Vertebrata; Virus immunodeficiency humaine; Lentivirinae; Retroviridae; Virus  
LO INIST-12239.354000032022160030

## DESCRIPTEURS

Anticorps  
Antigene  
Antigenicite  
Homme  
Immunogenicite  
Lapin  
Particule core  
Peptide  
Sequence aminoacide  
Specificite  
Virus HIV1

**LA MISE EN CORRESPONDANCE - DES OPTIONS BASSES**

# Classification Internationale des Brevets

⇒ UNE CLASSIFICATION TECHNIQUE ?

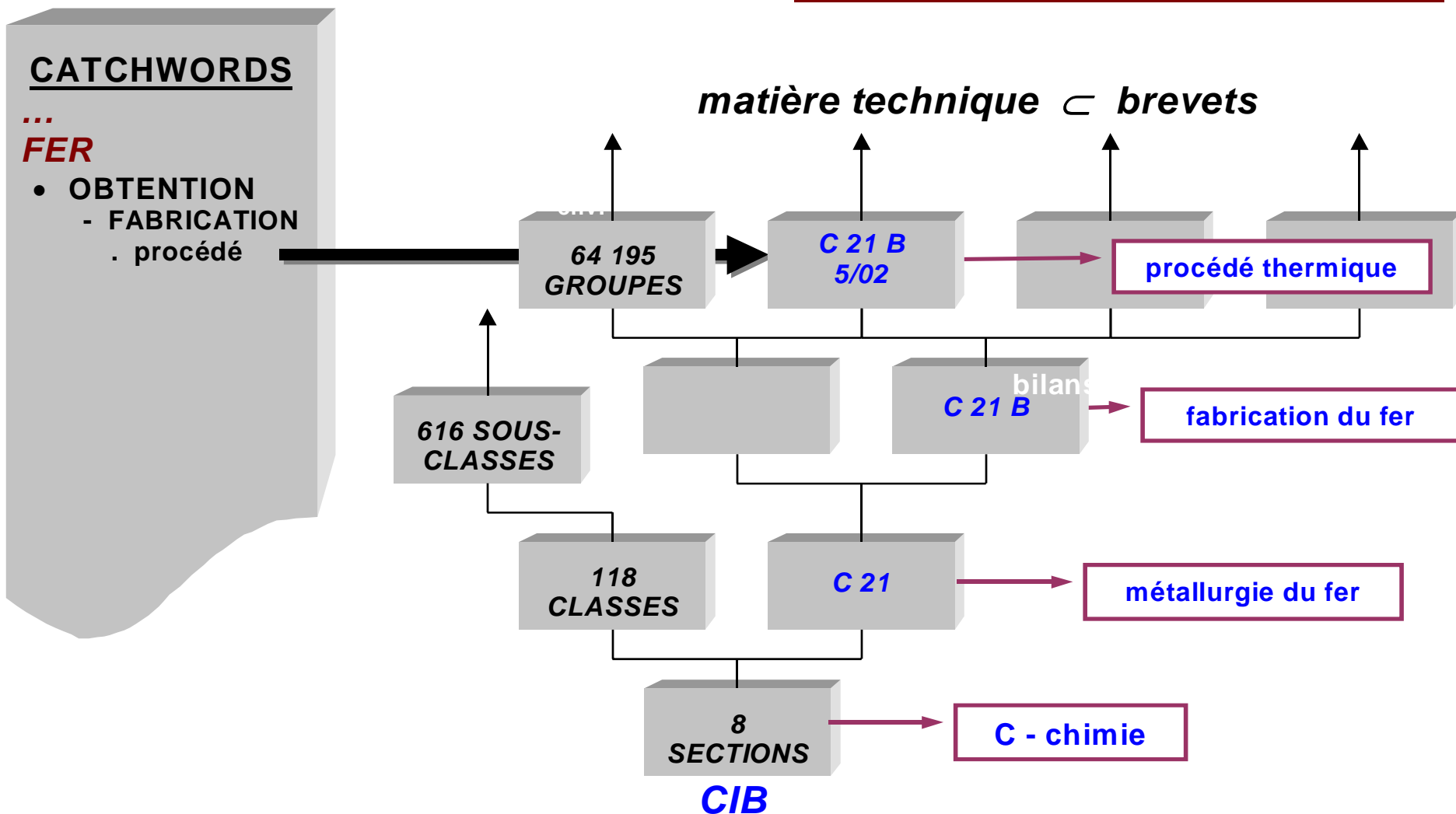

**LA MISE EN CORRESPONDANCE - DES OPTIONS BASSES**

# Les Catchwords

FER voir aussi ACIER, ALLIAGE, FONTE, METAL

(1°) Composés du FER

FERs minéraux

C 01 G 49/00\*

FERs organiques

C 07 F 15/02

FERs en tant que pigments ou charges

C 09 C 1/22

(2°) Obtention ou traitement du FER

Extraction du minerai de FER

E 21 C 41/22

E 21 C 41/30

Traitement préalable du minerai de FER

C 22 B 1/00

(a) Fabrication du FER

dans les fours ou hauts fourneaux

C 21 B

par des procédés métallo-thermiques

C 21 B 15/02

par électrolyse

C 25 C 1/00

de FER pudlé

C 21 C

de FER spongieux

C 21 B

(b) Traitement thermique du FER

.../...

LISTE DES CATCHWORDS

⇒ UN FORMAT  
HIERARCHIQUE ?

reformatage

AN CATCHWORD\_V.5\_8313  
EP FERS  
SA ACIER, ALLIAGE, FONTE, METAL  
ES OBTENTIONS TRAITEMENTS  
ET FABRICATIONS  
EQ PROCEDES METALLO-THERMIQUES  
IC C 21 B 15/02  
SO FER // (2°) Obtention ou traitement du  
FER // (a) Fabrication du FER // par des  
procédés métallo-thermiques

**LA MISE EN CORRESPONDANCE - UN MODELE DE LIENS A PRIORI**

# De nombreux essais fructueux

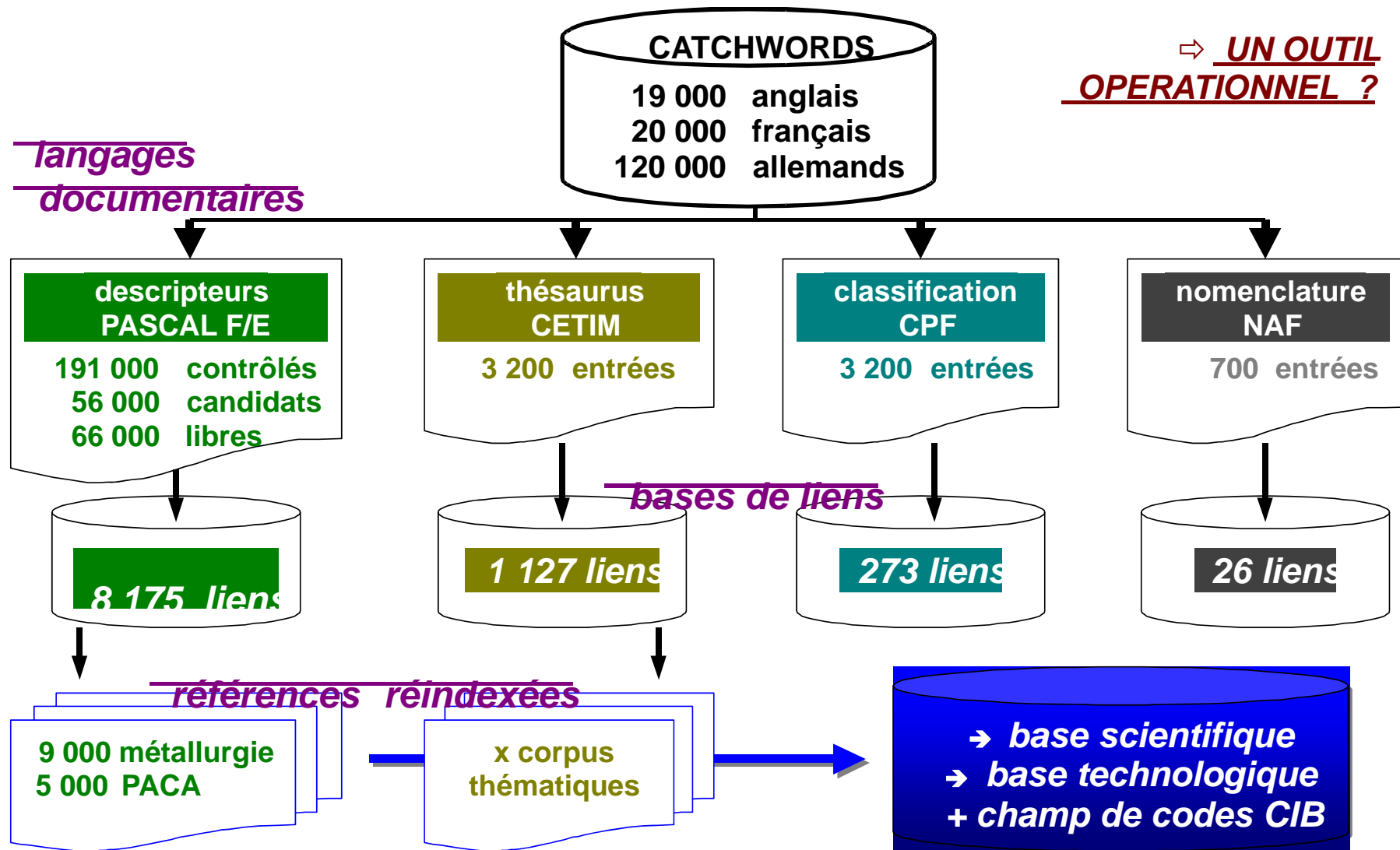

**LA MISE EN CORRESPONDANCE - METHODE AUTOMATIQUE DE LIENS**

# Des multiliens descripteurs

⇒ QUEL TYPE DE LIEN ?

**PASCAL\_METALLURGIE**  
**Descripteur** DÉGRAISSAGE  
**Référence** PASCAL\_1798

Densité globale des liens  
avec les Catchwords **25**

## Catchword(s) lié(s)

CATCHWORD\_V.5\_6029  
CATCHWORD\_V.5\_6032  
CATCHWORD\_V.5\_6030  
CATCHWORD\_V.5\_6031

40 %  
25 %  
18 %  
18 %

Référence CATCHWORD\_V.5\_6029  
Catchword original **DEGRAISSAGE // cuir (DEGRAISSAGE du)**  
Code CIB associé C 14 C 5/00

Référence CATCHWORD\_V.5\_6032  
Catchword original **DEGRAISSAGE // métaux en général (DEGRAISSAGE chimique des)**  
Code CIB associé C 23 G 5/00

Référence CATCHWORD\_V.5\_6030  
Catchword original **DEGRAISSAGE // fibres de laine en bourre (DEGRAISSAGE des)**  
Code CIB associé D 01 B 3/04  
Code CIB associé D 01 C 3/00

Référence CATCHWORD\_V.5\_6031  
Catchword original **DEGRAISSAGE // objets métalliques (DEGRAISSAGE électrolytique des)**  
Code CIB associé C 25 F 1/00

**LA MISE EN CORRESPONDANCE - METHODE AUTOMATIQUE DE LIENS**

# Un lien plus global?

AN 700/1949 - (C) CNRS  
FT **Kyste hydatique du rein de l'enfant**  
ET (Hydatid cyst of the kidney in children)  
AU PANUEL M; GOLDSTEIN P; DEVRED P; GUYS J M; FAURE F; GARNIER J M  
AF **CHU La Timone, serv. radiologie pediatrique/13385 Marseille/FRA; CHU La Timone, clin. chirurgicale infantile/13385 Marseille/FRA; CHU La Timone, serv. pediatrie/13385 Marseille/FRA**  
DT Periodique; LA  
SO Pediatrie : (Marseille); ISSN 0031-4021; Coden PEDRAN; FRA; DA. 1992; VOL. 47; NO. 11 ; PP. 779-783; ABS. fre/eng; BIBL. 10 ref.  
LA FRE  
CC 002B05E03A3  
IC **A61M-001/14**; A61B-017/00; A61B-019/00  
FD Tumeur; Exploration; Traitement; Enfant; Exploration ultrason; Echographie; Chirurgie; Kyste hydatique; Rein  
ED Tumor; Exploration; Treatment; Child; Sonography; Echography; Surgery; Hydatid cyst; Kidney  
LO INIST-3909.354000032735060070

**OBJET SCIENTIFIQUE**

*FRE IPC5 CatchW*

**REIN**

**REIN artificiel A 61 M 1/14**

*FRE IPC5*

**A 61 M 1/14 . Systèmes de dialyse; Reins artificiels; Oxygénateurs du sang**  
(procédés de séparation utilisant des membranes semi-perméables B 01 D 61/00, des membranes semi-perméables caractérisées par leurs matériaux, leurs procédés de fabrication B 01 D 71/00) [4]

**OBJET TECHNIQUE**

**RESULTATS EXPERIMENTAUX - REINJECTION DES CODES CIB**

# Un lien très large ou trop large

## PASCAL

AN 34/1949 - (C) CNRS  
ET Specificity of anti-P25 antibodies produced against whole HIV-1 particles or soluble forms of the protein  
AU KAMEL MABROUK; ABDELAZIZ BENJOUAD; GLUCKMAN J C; ROCHAT H; VAN RIETSCHOTEN J; ELMOSTAFA BAHRAOUI  
AF CNRS Fac. medecine Nord, lab. biochimie/13326 Marseille/FRA; CNRS Hop. Pitie-Salpetriere, lab. biologie genetique pathologies immunitaires/75651 Paris/FRA  
DT Periodique; LA  
SO Molecular immunology; ISSN 0161-5890; Coden MOIMD5; GBR; DA. 1992; VOL. 29; NO. 11 ; PP. 1309-1318; BIBL. 1 p. 1/2  
LA ENG  
EA Specificity of anti-p25 antibodies produced against either whole Human Immunodeficiency Virus type 1 (HIV-1) particles in humans and chimpanzees, or against soluble forms of the protein in chimpanzees and rabbits was analyzed by ELISA using a panel of 37 long (30 residues) or shorter (9-21 residues) overlapping peptides covering the entire p25 sequence. Antibodies elicited by intact virions presented similar reactivity patterns in HIV-1-infected humans and in HIV-1-infected or immunized chimp:  
CC 002A06C05C  
IC **C07K-000/00; A01K-001/02** → **Porcheries; Niches; Clapiers à lapins ou similaires**  
FD Lapin; Virus HIV1; Antigene; Particule core; Peptide; Specificite; Anticorps; Homme; Antigenicite; Immunogenicite; Sequence aminoacide  
ED Rabbit; HIV-1 virus; Antigen; Core particle; Peptides; Specificity; Antibody; Human; Antigenicity; Immunogenicity; Aminoacid sequence  
FG Lagomorpha; Mammalia; Vertebrata; Virus immunodeficiency humaine; Lentivirinae; Retroviridae; Virus  
LO INIST-12239.354000032022160030

**RESULTATS EXPERIMENTAUX - REINJECTION DES CODES CIB**

# Antidictionnaire: une situation dangereuse

⇒ **CODES CIB ASSOCIES ?**

**ICM A23C-009/00**

**CIB Préparations à base de lait; Lait en poudre ou préparations à base de lait en poudre (A 23 C 21/06 a priorité; conservation A 23 C 3/00; lait chocolat, A 23 G 1/00; crèmes glacées, mélanges pour la préparation des crèmes glacées A 23 G 9/00; flans ou entremets, poudres sèches à flans ou entremets A 23 L 1/187) [3]**

**ICM A41D-011/00**

**CIB Vêtements pour enfants**

**ICM A43B-003/30**

**CIB Chaussures caractérisées par la forme ou l'utilisation**

**ICM A47D-001/00**

**CIB Chaises d'enfants (chaises en général A 47 C)**

**ICM A47D-003/00**

**CIB Tables d'enfants**

**ICM A47D-007/00**

**CIB Lits d'enfants (lits en général A 47 C)**

**ICM A47D-013/06**

**CIB Autres meubles de pouponnières (sièges de toilette auxiliaires ou transportables pour enfants A 47 K 13/06)**

**ICM A47D-013/10**

**CIB Autres meubles de pouponnières (sièges de toilette auxiliaires ou transportables pour enfants A 47 K 13/06)**

**ICM A47K-003/02**

**CIB Baignoires; Douches; Leurs accessoires (à usage médical A 61 H, A 61 M)**



# L 'université doit aussi veiller...

requête : biodegradation

PASCAL

A1

AN PASCAL 93-0494817 INIST

ET **Hydrocarbon biodegradation and hydrocarbonoclastic bacterial communities composition grown in seawater as a function of sodium chloride concentration**

AU BERTRAND J C; BIANCHI M; AL MALLAH M; ACQUAVIVA M; MILLE G

AF Cent. oceanologie Marseille/13288 Marseille/FRA; CNRS Fac. sci. Luminy, lab. microbiologie marine/Marseille/FRA; CNRS Fac. sci. tech. Saint Jerome, lab. chimie analytique environnement/Marseille/FRA

DT Periodique; LA

SO Journal of experimental marine biology and ecology; ISSN 0022-0981; Coden JEMBAM; NLD; DA. 1993; VOL. 168; NO. 1 ; PP. 125-138; BIBL. 22 ref.

LA ENG

CC 002A14C02

ED Environmental factor; Salinity; Pollutant; Hydrocarbon; Bacteria; **Biodegradation**; NaCl structure; Concentration factor; France

**IC C12N-001/20**

**C 12 N 1/00**

*FRE IPC5*

**Micro-organismes en soi**, p. ex. protozoaires; Compositions les contenant (préparations à usage médical contenant des substances provenant de micro-organismes A 61 K 35/66; préparation de compositions à usage médical contenant des antigènes ou des anticorps bactériens, p. ex. de vaccins bactériens, A 61 K 39/00); Procédés de culture ou de conservation de micro-organismes, ou de compositions les contenant; Procédés de préparation ou d'isolement d'une composition contenant un micro-organisme; Leurs milieux de culture (produits alimentaires contenant des micro-organismes ou procédés pour les préparer A 21, A 23) [3]

**1/20 . Bactéries; Leurs milieux de culture [3]**

**EVALUATION ET PERSPECTIVES - UN LIEN POUR LE VEILLEUR**

# Antériorité de l'université?

B1

requête : C12N001-20 and biodegrad?

CHEMICAL ABSTRACTS

AN 124:184618 CA COPYRIGHT 1996 ACS  
TI Corynebacterium sp. j1, method for \*\*\*biodegradation\*\*\* of aromatic compounds and/or chlorinated organic compounds, and method for environmental remediation using it  
IN Kozaki, Shinya; Kato, Kinya; Yano, Tetsuya; Imamura, Takeshi  
PA **Canon K. K., Japan**  
SO Eur. Pat. Appl., 18 pp. CODEN: EPXXDW  
PI EP 694611 A2 960131  
DS R: AT, BE, CH, DE, DK, ES, FR, GB, GR, IE, IT, LI, LU, MC, NL, PT, SE  
AI EP 95-303580 950526  
PRAI JP 94-116268 940530 JP 94-116269 940530 JP 94-139903 940622 JP 95-127671 950526  
DT Patent  
LA English  
IC ICM \*\*\***C12N001-20**\*\*\* ICS C02F003-34  
ICI C12N001-20, C12R001-15  
CC 60-1 (Waste Treatment and Disposal)  
AB **A novel bacterial strain**, Corynebacterium sp. J1 (FERM BP-5102), which can effectively degrade arom. compds. and/or chlorinated org. compds. such as trichloroethylene (TCE) even at **lower temp.**, and a **method for purifying wastewater, soil or a gas polluted with the above chem. compds.** utilizing the bacterium are described.

**bactérie concurrente**

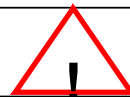

**aucun descripteur commun**

**EVALUATION ET PERSPECTIVES - UN LIEN POUR LE VEILLEUR**

# La Veille amène des réflexions!!

A2

requête : biodegradation

PASCAL

AN PASCAL 94-0339414 INIST

ET The potential **application of biosurfactants in combatting hydrocarbon pollution in marine environments** :  
"Scientific and technological issues leading to the practical application of bioremediation and environmental biotechnology"

AU BERTRAND J C; BONIN P; GOUTX M; GAUTHIER M; MILLE G

AF CNRS, cent. oceanologie Marseille, URA 41/13288 Marseille/FRA; CNRS Fac. sci. tech. Saint-Jerome, lab. chimie analytique/13397 Marseille/FRA; INSERM, U 303/06300 Nice/FRA

DT Periodique; LA

SO Research in microbiology : (Paris); ISSN 0923-2508; FRA; DA. 1994; VOL. 145; NO. 1 ; PP. 53-56; BIBL. 23 ref.

LA ENG

CC 002A31D07F; 215

ED Acinetobacter calcoaceticus; Saccharomycopsis lipolytica; Yeast; Marine environment; Water pollution; Hydrocarbon; Biological treatment; **Biodegradation**; Emulsifier; Surfactant; Ecological recovery; Oil spill

**IC C11D-000/00; B01F-017/00**

**B 01 F 17/00**

FRE IPC5

**Utilisation de substances comme agents émulsifiants**, humidifiants, dispersants ou générateurs de mousse (agents de flottation B 03 D 1/001; pour des applications particulières, voir les classes appropriées, p. ex. en tant que détergents C 11 D) [3. 5]

**C 11 D**

FRE IPC5

**COMPOSITIONS DETERGENTES** (préparations spécialement prévues pour le lavage des cheveux A 61 K 7/075; compositions de lavage particulières pour le nettoyage de membranes semi-perméables B 01 D 65/06); EMPLOI D'UNE SUBSTANCE, UTILISEE SEULE, COMME DETERGENT; SAVON OU FABRICATION DU SAVON; SAVONS DE RESINE: RECUPERATION DE LA GLYCERINE

**EVALUATION ET PERSPECTIVES - UN LIEN POUR LE VEILLEUR**

# Solution alternative?

B2

requête : (C11D000-00 or B01F017-00) and biodegrad?

CHEMICAL ABSTRACTS

AN 114:149890 CA COPYRIGHT 1996 ACS  
TI Dispersant compositions for treating oil slicks on cold water  
IN Charlier, Alain  
PA **Fina Research S. A., Belg.**  
SO Eur. Pat. Appl., 7 pp. CODEN: EPXXDW  
PI EP 398860 A2 901122  
DS R: BE, DE, DK, ES, FR, GB, GR, IT, NL, SE  
AI EP 90-870072 900514  
PRAI US 89-351985 890515

DT Patent  
LA English  
IC ICM \*\*\***B01F017-00**\*\*\* ICS C02F001-68  
CC 61-5 (Water)

AB **The oil slick dispersant contains** 50-60 wt.% of a surfactant mixt. contg. 55-65 wt.% of emulsifiers consisting of a blend A of sorbitan monooleate (I) and a I polyoxyethylene deriv. and a blend B consisting of sorbitan trioleate and I polyoxyethylene deriv., where the blend A: blend B ratio is (0.5:1)-(4:1), and 35-45 wt.% of Na dioctylsulfosuccinate wetting agent. The mixt. also contains water 10-30, hydrocarbon solvents, e.g., kerosine 15-25, and a polyoxyalkylene glycol ether of the formula  $HO(C_mH_{2m}O)_x C_nH_{2n+1}$ , where  $m = 2-3$ ,  $x = 1-3$ , and  $n = 1-6$ . The HLB of the blend A and and the blend B are 8.75-9.5 and 8-10, resp. **The compn. is esp. effective for use on cold water, e.g., seawater, and on rough and calm water. It is nontoxic and biodegradable, inexpensive,** and can be sprayed from boats or aircraft.

**technique de substitution**

**! aucun descripteur commun**

**EVALUATION ET PERSPECTIVES - UN LIEN POUR LE VEILLEUR**

# Des partenaires sur mesure pour l'université

21 C12N001-20  
11 C02F003-34  
3 C12N001-00  
2 B09B003-00  
2 C02F003-00  
2 C12N001-14

28 C12N  
19 C02F

**C 12 N**  
MICRO-ORGANISMES OU ENZYMES; COMPOSITIONS LES CONTENANT; CULTURE OU CONSERVATION DE MICRO-ORGANISMES; TECHNIQUES DE MUTATION OU DE GENETIQUE; MILIEUX DE CULTURE

**C 02 F**  
TRAITEMENT DE L'EAU, DES EAUX RESIDUAIRES, DES EAUX OU BOUES D'EGOUT

*voie biologique*

2 CANON K. K., **JAPAN/PA**  
1 BARTL, LUDWIG, CZECH REP./PA  
1 CELGENE CORPORATION, **USA/PA**  
1 CIBA-GEIGY A.-G., SWITZ./PA  
1 ECOVA CORP., **USA/PA**  
1 FED. REP. GER./PA  
1 FELBER, JOSEF/PA  
1 FUJITSU LTD, **JAPAN/PA**  
1 GENERAL ELECTRIC CO., **USA/PA**  
1 GOODRICH, B. F., CO., **USA/PA**  
1 HOECHST A.-G., FED. REP. GER./PA  
1 IDAHO RESEARCH FOUNDATION, INC., **USA/PA**  
1 KIRIN BEER K. K., **JAPAN/PA**  
1 KOKURITSU KANKYO KENKYUSHO, **JAPAN/PA**

100 B01F017-00  
10 A61K007-50  
8 B01J013-00  
7 C11D001-83  
6 A01N025-04  
6 A61K007-075

100 B01F  
42 A61K

**B 01 F**  
MELANGE, p. ex. DISSOLUTION, EMULSION, DISPERSION

**A 61 K**  
PREPARATIONS A USAGE MEDICAL, DENTAIRE OU POUR LA TOILETTE

*voie chimique*

9 HENKEL K.-G.A.A., **GERMANY/PA**  
8 HENKEL KGAA, **GERMANY/PA**  
3 BASF A.-G., **GERMANY/PA**  
3 HOECHST A.-G., **GERMANY/PA**  
2 CO OP CHEMICAL CO LTD/PA  
2 IFAC GMBH, **GERMANY/PA**  
2 KOGYO GIJUTSUIN, JAPAN/PA  
2 NIPPON OILS & FATS CO LTD, JAPAN/PA  
2 PEOP. REP. CHINA/PA  
2 PULCRA S.A./PA  
2 RHONE-POULENC CHIMIE, FR./PA  
2 RHONE-POULENC INC., USA/PA  
2 RHONE-POULENC SPECIALTY CHEMICALS CO., USA/PA  
2 SANDOZ-PATENT-G.M.B.H., **GERMANY/PA**

**EVALUATION ET PERSPECTIVES - INFORMATION POUR L'EXPERT**

# L'OMPI a fait la même chose??? NON!!!

## JOPAL-OMPI

IC- C12N001/20, C12P005/02

AU- Marty D G et al

TI- Isolement de deux souches méthanogènes thermophiles appartenant au genre Methanobacterium

JO- Comptes-rendus des Séances de l'Académie des Sciences

JN- Compt. Acad. Sci. Fr.

LA- Fr

YR- 1981

VO- 292

IS- 3,1

PG- 41 - 43

⇒ DIVERGENCE OU  
COMPLEMENTARITE ?

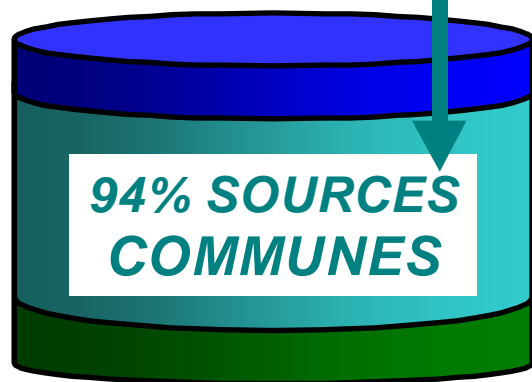

JOPAL

sélections #

PASCAL

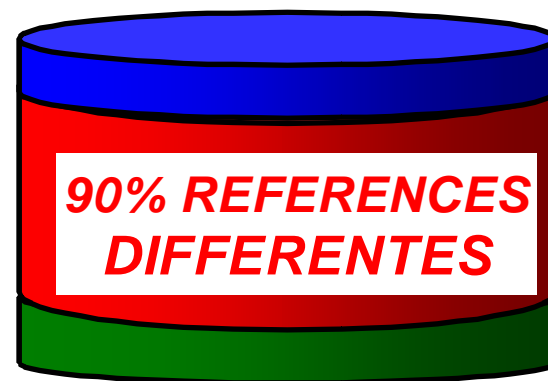

**EVALUATION ET PERSPECTIVES - DES PISTES A SUIVRE...**

# Une information nouvelle: le passage Scientifique $\rightleftarrows$ Technique

## 1 ARTICLE SCIENTIFIQUE

AN 34/1949 - (C) CNRS  
ET Specificity of anti-P25 antibodies produced against whole HIV-1 particles or soluble forms of the protein  
AU KAMEL MABROUK; ABDELAZIZ BENJOUAD; GLUCKMAN J C; ROCHAT H; VAN RIETSCHOTEN J;  
ELMOSTAFA BAHR AOUI  
AF CNRS Fac. medicine Nord, lab. biochimie/13326 Marseille/FRA; CNRS Hop. Pitie-Salpetriere, lab. biologie  
genetique pathologies immunitaires/75651 Paris/FRA  
DT Periodique; LA  
SO Molecular immunology; ISSN 0161-5890; Coden MOIMDS; GBR; DA. 1992; VOL. 29; NO. 11 ; PP. 1309-1318;  
BIBL. 1 p. 1/2  
LA ENG  
EA Specificity of anti-p25 antibodies produced against either whole Human Immunodeficiency Virus type 1 (HIV-1)  
particles in humans and chimpanzees, or against soluble forms of the protein in chimpanzees and rabbits was  
analyzed by ELISA using a panel of 37 long (30 residues) or shorter (9-21 residues) overlapping peptides covering  
the entire p25 sequence. Antibodies elicited by intact virions presented similar reactivity patterns in HIV-1-  
infected humans and in HIV-1-infected or immunized chimpanzees and recognized only a limited region mostly  
the C-terminus of the molecule  
CC 002A06C05C  
FD Lapis; Virus HIV1; Antigene; Particule core; Peptide; Specificite; Anticorps; Homme; Antigenicite;  
Immunogenicite; Sequence nucleide  
ED Rabbit; HIV-1 virus; Lapis; Core particle; Peptides; Specificity; Antibody; Human; Antigenicity;  
Immunogenicity; Amino acid sequence  
FG Lagomorpha; Mammalia; Vertebrata; Virus immunodeficiency humaine; Lentivirinae; Retroviridae; Virus  
LO INIST-12239.3540000 022160030

## 1 DOCUMENT DE BREVET

Code CIB x  
IC- C12N001/20, C12P005/02  
AU- Marty D G et al  
TI- Isolement de deux souches méthanogènes thermophiles appartenant au genre  
Methanobacterium  
JO- Comptes-rendus des Séances de l'Académie des Sciences  
JN- Compt. Acad. Sci. Fr.  
LA- Fr  
YR- 1981  
VO- 292  
IS- 3,1  
PG- 41 - 43



rein artificiel // pathologie rénale  
meuble enfant // réanimation infantile  
clapier à lapins // étude HIV  
chambre froide // diabète légal



*un lien, pas une information*

# La réelle évaluation: par l'usage

RECHERCHE  
ACADEMIQUE

Publications  
scientifiques

BANQUES  
DE DONNEES  
SCIENTIFIQUES

PASCAL  
11 M réf.

*recherches croisées  
statistiques en ligne*

INVENTIONS  
TECHNIQUES

Documents  
de brevet

BANQUES  
DE DONNEES  
TECHNIQUES

*passerelle*  
↑  
*outil  
opérationnel*

WPI  
13 M

# Brevets de domaine Publique

Wanise Barroso 10/07/2003

- ◆ Examinadora de Patente INPI
- ◆ Atualmente Farmanguinhos/Fiocruz  
<http://www.far.fiocruz.br/principal.htm>



# Motivos para elaborar a base de dados

- PMEs são de extrema importância para o país
- Dotar as PMEs com ferramentas eficazes para implementar tecnologia
- Interesse social
- Desenvolvimento tecnológico
- Disseminação de informação

# Documentos considerados

- \* Patente de invenção - PI
- \* Período 1971 a 2001
- \* Total de documentos 245.225
- \* SINPI - BASE DE DADOS DO INPI

# Legislação

- **Lei da Propriedade Industrial**  
**9.279 de 14/05/96**
- **Código da Propriedade Industrial**  
**5.772 de 21/12/71**

# Quando um documento de patente pode ser extinto?

**Extinção da patente**

**Extinção do pedido de patente**

# **Extinção da patente**

- 1 - Patentes com expiração do prazo de vigência (20 anos)**
- 2 - Renúncia da patente pelo titular**
- 3 - Patentes caducas**
- 4 - Falta de pagamento de anuidade da patente**
- 5 - Falta de constituição e manutenção de procurador no Brasil para pessoa domiciliada no exterior**
- 6 - Patentes anuladas**

# **Extinção do pedido de patente**

**1 - Pedidos de patente indeferidos**

**2 - Pedidos de patente arquivados**

# Pedidos em domínio público

ANO	1986	1987	1988	1989	1990	1991	1992	1993	1994	1995	TOTAL
QN. Ped. Dep.	7.227	7.985	7900	7.890	8.025	7.314	7.189	7.923	8.646	10.671	80.77
Arq. N. anuid	<b>5</b> 0,07%	<b>23</b> 0,29%	<b>64</b> 0,81%	<b>170</b> 2,15%	<b>313</b> 3,9%	<b>460</b> 6,29%	<b>242</b> 3,37%	<b>36</b> 0,46%	<b>20</b> 0,23%	<b>11</b> 0,10%	
Indef	<b>534</b> 7,39%	<b>562</b> 7,03%	<b>365</b> 4,62%	<b>311</b> 3,94%	<b>413</b> 5,15%	<b>561</b> 7,67%	<b>708</b> 9,85%	<b>742</b> 9,36%	<b>761</b> 8,80%	<b>203</b> 1,9%	
Arq. N. Ped. exam	<b>1.573</b> <b>21,75</b>	<b>1.935</b> <b>24,23</b>	<b>1.880</b> <b>23,80</b>	<b>1.963</b> <b>24,88</b>	<b>2.464</b> <b>30,70</b>	<b>2.025</b> <b>27,68</b>	<b>1.427</b> <b>19,84</b>	<b>999</b> <b>12,61</b>	<b>1.825</b> <b>21,10</b>	<b>2.576</b> <b>24,14%</b>	
Arq. N. Exig.	<b>861</b> 11,91	<b>961</b> 12,03	<b>861</b> 10,90	<b>731</b> 9,24	<b>634</b> 7,90%	<b>697</b> 9,53%	<b>784</b> 10,9%	<b>756</b> 9,54%	<b>566</b> 6,56%	<b>179</b> 1,68%	
Dom. Publ.	<b>2.973</b> 41,14	<b>3.481</b> 43,59	<b>3.170</b> 40,13	<b>3.175</b> 40,24	<b>3.824</b> 47,65	<b>3.743</b> 51,17	<b>3.161</b> 43,97	<b>2.533</b> 31,97	<b>3.172</b> 36,7	<b>2.969</b> 27,82	<b>32.201</b> ~40%

# Conclusão

<i>Idade dos pedidos de patente (anos)</i>	<i>Total de pedidos depositados</i>	<i>Total de docs. em domínio público</i>	<i>% de docs. em domínio público</i>
<b>11 a 14</b> (1986 a 1989)	31.002	12.799	41,28%
<b>9 e 10</b> (1990 e 1991)	15.339	7.567	40,33%
<b>7 e 8</b> (1992 e 1993)	15.112	5.695	37,68%
<b>5 e 6</b> (1994 e 1995)	19.317	6.141	31,79%
<b>3 e 4</b> (1996 e 1997)	27.858	60	0,22%

# Limite des recherches d'information classiques

- ◆ A initié les travaux de Jean Dominique Pierret
- ◆ Ingénieur Galderma  
<http://www.galderma.com/>



# Recherche de compétences

- Recherche d'entreprises à plusieurs domaines de compétence (Avec R&D)

– Pain, Vin, Fromage

- Pour un client dans le domaine des fast-food
- La réponse peut être dans des bases de données formelles  
**mais**
- **les opérateurs Booléens classiques ne suffisent pas à la constituer**

# Les Booléens sont insuffisants

SS 1?

~wine and bread and cheese

OCCURS	TERM
--------	------

5195	WINE
------	------

6339	BREAD
------	-------

5343	CHEESE
------	--------

SS 1 RESULT (5)

SS 2?

~wine or bread or cheese

OCCURS	TERM
--------	------

5195	WINE
------	------

6339	BREAD
------	-------

5343	CHEESE
------	--------

SS 2 RESULT (16593)

# Les 7 entreprises trouvées avec AND

- (EUEU-) EUROPE CO LTD
- (FUER-) FUERSTLICHE BRAUEREI
- (FUER-) FUERSTLICHE BRAUEREI THURN & TAXIS
- (KYOW ) KYOWA HAKKO KOGYO CO LTD
- (KYOW ) KYOWA HAKKO KOGYO KK
- (MURA/) MURAKAMI H
- (UNIV ) UNIV KANSAS STATE RES FOUND

# Murakami: appâts empoisonnés pour les rats

AN - 88-096323/14

XRAM- C88-043414

TI - Rat attractant - contains alcohol e.g. sake, wine etc. impregnated into food

DC - C03 P14

PA - (MURA/) MURAKAMI H

NP - 2

PN - J63048205-A 88.02.29 (8814) {JP}  
CN8704002-A 88.02.10 (8913)

PR - 86.08.19 86JP-193677 86.06.03 86JP-U84682 86.06.10 86JP-135192  
86.07.30 86JP-V17378

AP - 86.08.19 86JP-193677

IC - A01N-031/04 A01N-063/00 A01M-023/16

AB - (J63048205)

Pref. alcohol is Japanese sake, wine, brandy, etc., and is impregnated on bread, sweet potato, cheese, soybean, peanut, etc.

ADVANTAGE - Attracts rats continuously, and it is possible to catch rats continuously. Rats which have taken the attractant become drunk and the warning reaction of rats is reduced. (2pp Dwg.No.0/0)

# Synoptique

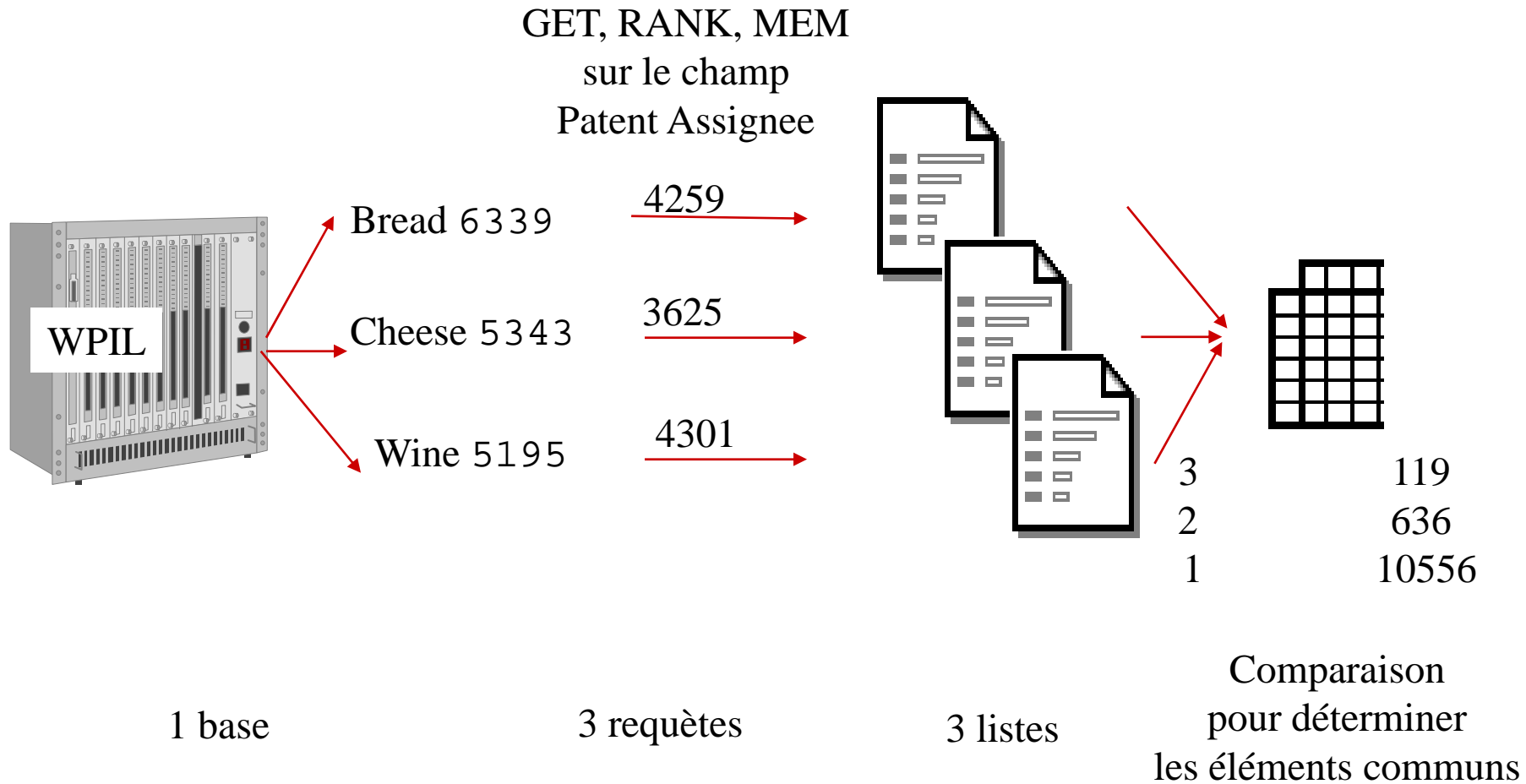

# Exemple de GET

```
~get pa rank top 5000
```

OCCURRENCES	PERCENT	TERM
45	0.86%	KRASD POLY
23	0.44%	KIKKOMAN CORP
20	0.38%	SUNTORY LTD
18	0.34%	SAPPORO BREWERIES
17	0.32%	DAINIPPON PRINTING CO LTD
17	0.32%	NOVO-NORDISK AS
16	0.30%	RIEGER H
15	0.28%	TOPPAN PRINTING CO LTD
14	0.26%	KIRIN BREWERY KK
14	0.26%	KYOWA HAKKO KOGYO KK
12	0.23%	SARISHVILI N G
11	0.21%	CANNING VEGETABLES DRYING IND
11	0.21%	MERCIAN CORP
11	0.21%	ODESS FOOD IND TECH
11	0.21%	WANG J
10	0.19%	MOSC FOOD IND TECHN
10	0.19%	MOSC MAGARACH WINE

# Les 119 recherchés

AIR LIQUIDE SA  
AJINOMOTO KK  
AKAD WISSENSCHAFT DDR  
ALKO LTD  
ASAHI CHEMICAL IND KK  
ASAHI DENKA KOGYO KK  
ASAHI KASEI KOGYO KK  
BASF AG  
BATTELLE MEMORIAL INST  
BAYER AG  
BODY SONIC KK  
BODYSONIC KK  
BOLSHEVIK STOCK CO  
CONSEJO SUPERIOR INVESTIGACION  
CPC INT INC  
CULTOR LTD  
DAICEL CHEM IND LTD  
DAINIPPON INK CHEM KK  
DAINIPPON PRINTING CO LTD  
DOW CHEM CO  
DU PONT DE NEMOURS & CO E I  
DU PONT DE NEMOURS CO  
**EUROPE CO LTD**  
EXTRAMURAL FOOD IND  
FISCHER H  
FMC CORP  
FOOD IND CORRESPONDENCE INST  
**FUERSTLICHE BRAUEREI**  
**FUERSTLICHE BRAUEREI THURN & TAXIS**  
FUJI ELECTRIC CO LTD  
FUJISAWA PHARM CO LTD  
GENERAL FOODS CORP  
GIST-BROCADES BV  
GIST-BROCADES NV  
GRACE W R CO  
GUNZE KK  
HASEGAWA CO LTD  
HASEGAWA KK  
HETEROORG CPDS INST  
HOECHST AG

HOUSE SHOKUHIN KOGY  
HOUSE SHOKUHIN KOGYO KK  
INRA INST NAT RECH AGRONOMIQUE  
INST NAT RECH AGRON  
INST NAT RECH AGRONOMIQUE  
INT FLAVORS & FRAGR INC  
ISHIDA S  
ISHIHARA S  
KAGOME KK  
KANEBO LTD  
KANEGAFUCHI CHEM KK  
KAO CORP  
KIBUN KK  
KIEV FOOD IND TECHN  
KIKKOMAN CORP  
KIMURA N  
KIRIN BREWERY KK  
KRAFT GEN FOODS INC  
KRASD POLY  
**KYOWA HAKKO KOGYO CO LTD**  
**KYOWA HAKKO KOGYO KK**  
LION CORP  
LODERS CROKLAAN BV  
MATSUSHITA ELEC IND KK  
MEIJI MILK PRODS KK  
MEIJI SEIKA KAISHA  
MERCK & CO INC  
MICROLIFE TECHNICS  
MITSUBISHI ELECTRIC CORP  
MITSUI PETROCHEM IND KK  
MOGIL TECHN INST  
MONSANTO CO  
MORINAGA & CO LTD  
MORINAGA MILK IND CO LTD  
MOSC FOOD IND TECHN  
MOSCOW MEAT DAIRY INST  
MOSCOW NAT ECONOMY INST  
**MURAKAMI H**  
NAKANO SUMISE KK  
NAKAYAMA S

NESTEC SA  
NIPPON OILS & FATS KK  
NISSHIN FLOUR MILL KK  
NITTO DENKO CORP  
NOVO-NORDISK AS  
ODESS FOOD IND TECH  
OTA T  
PROCTER & GAMBLE CO  
Q.P. CORP  
QP CORP  
QUEST INT BV  
RENNO SUISAN KK  
RHONE POULENC CHIM  
SAN EI CHEM IND KK  
SATO M  
SEKISUI CHEM IND CO LTD  
SHIMADZU CORP  
SHOWA DENKO KK  
SNOW BRAND MILK PROD CO LTD  
SNOW BRAND MILK PRODUCTS  
SOC PROD NESTLE SA  
STAVROPOL POLY  
SUMITOMO ELEC IND KK  
SUNTORY LTD  
SUZUKI K  
TAKARA SHUZO CO LTD  
TAKEDA CHEMICAL IND KK  
TANABE SEIYAKU KK  
TETRA LAVAL HOLDINGS & FINANCE SA  
TOKYO GAS CO LTD  
TOPPAN PRINTING CO LTD  
TOPPAN PRINTING KK  
UBE INDUSTRIES KK  
UNILEVER LTD  
UNILEVER NV  
UNILEVER PLC  
**UNIV KANSAS STATE RES FOUND**  
VORON TECH INST  
VORON TECHN INS

# Quelles compétences

	Bread	Cheese	Wine
AIR LIQUIDE SA	1	2	3
AJINOMOTO KK	35	27	4
AKAD WISSENSCHAFT DDR	7	16	1
ALKO LTD	1	1	1
ASAHI CHEMICAL IND KK	6	16	3
ASAHI DENKA KOGYO KK	12	11	1
ASAHI KASEI KOGYO KK	7	6	3
BASF AG	1	1	5
BATTELLE MEMORIAL INST	2	1	1
BAYER AG	2	2	4
BODY SONIC KK	1	1	3
BODYSONIC KK	1	1	3
BOLSHEVIK STOCK CO	1	5	5
CONSEJO SUPERIOR INVESTIGACION	2	2	1
CPC INT INC	6	4	1
CULTOR LTD	2	1	1
DAICEL CHEM IND LTD	1	3	3
DAINIPPON INK CHEM KK	4	1	1
DAINIPPON PRINTING CO LTD	2	2	17
DOW CHEM CO	1	3	1
DU PONT DE NEMOURS & CO E I	2	4	3
DU PONT DE NEMOURS CO	3	1	4
EUROPE CO LTD	1	1	1
EXTRAMURAL FOOD IND	1	1	2
FISCHER H	2	1	1
FMC CORP	3	11	2
FOOD IND CORRESPONDENCE INST	4	1	5
FUERSTLICHE BRAUEREI	3	1	1
FUERSTLICHE BRAUEREI THURN & TAXIS	2	1	1

# Et s 'il en fallait plus...

	Bread	Cheese	Wine
NIPPON SEIFUN KK	47	2	0
RHEON AUTOMATIC MACHINERY CO	40	3	0
YAMAZAKI SEIPAN KK	31	1	0
ASAHI DENKA KOGYO	23	10	0
MIYOSHI YUSHI KK	20	9	0
FUJI OIL KK	19	41	0
PILLSBURY CO	17	13	0
SEB SA	14	5	0
...			
MATSUSHITA DENKI SANGYO KK	50	0	1
TOSHIBA KK	38	0	4
NISSHIN FLOUR MILLING CO	37	0	1
ORIENTAL YEAST KK	31	0	1
ORIENTAL YEAST CO LTD	21	0	4
TOSHIBA KIKI KK	14	0	1
MATSUSHITA ELEC IND CO LTD	13	0	4
HITACHI KK	11	0	3
MATSUSHITA ELECTRIC IND CO LTD	11	0	1
mitsubishi KASEI CORP	10	0	4
...			
ROKKO BUTTER KK	0	30	1
GRACE & CO-CONN W R	0	21	2
TORAY IND INC	0	16	3
TEIJIN KK	0	11	1
...			



# Phases de recherche et développement d'un médicament

Un processus :

→ coûteux : 820 millions US\$ par médicament  
(18% du chiffre d'affaires consacré à la R&D)

→ risqué : 1 molécule sur 10.000 deviendra un médicament

→ long : 10 ans d'efforts pour créer un médicament

# Utilisations possibles du KDD dans la création de nouveaux traitements

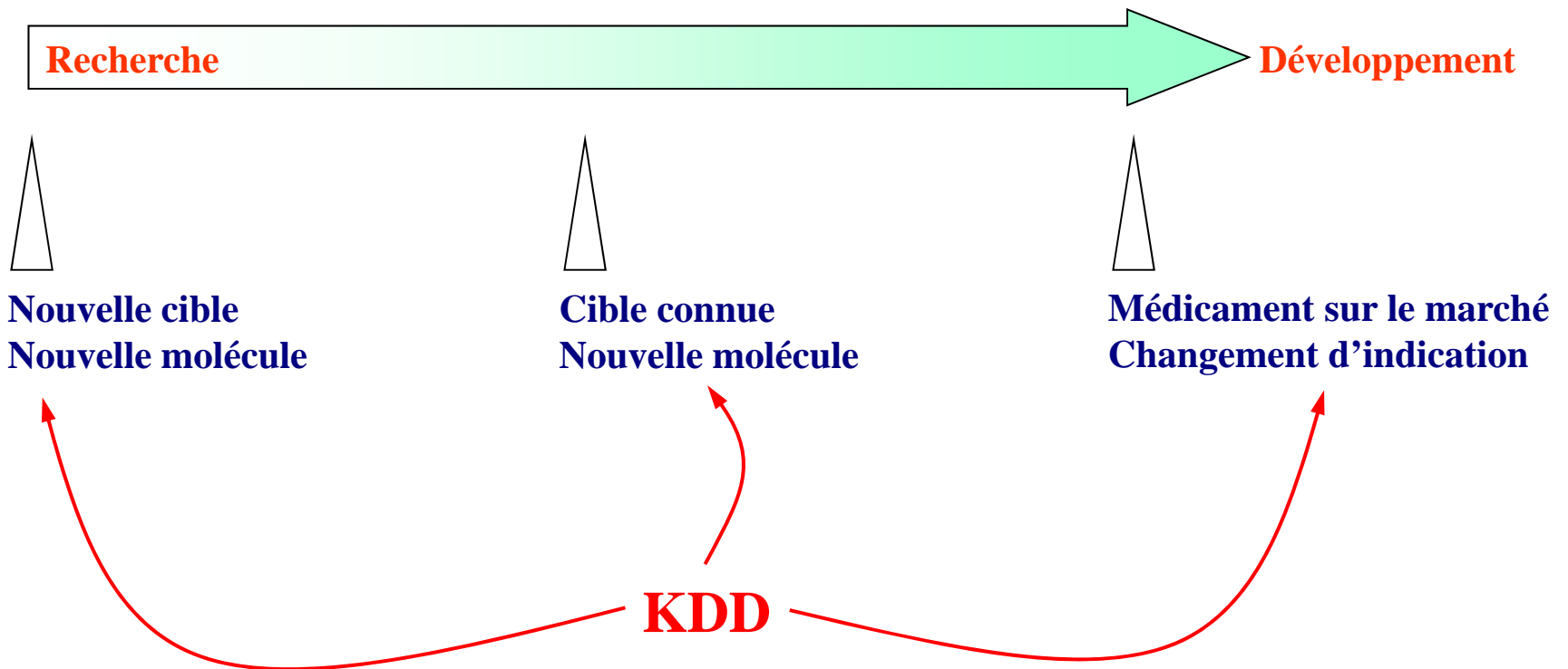

*D'après Pierret (2005)*

# Principe de logique non booléenne : le modèle de Swanson

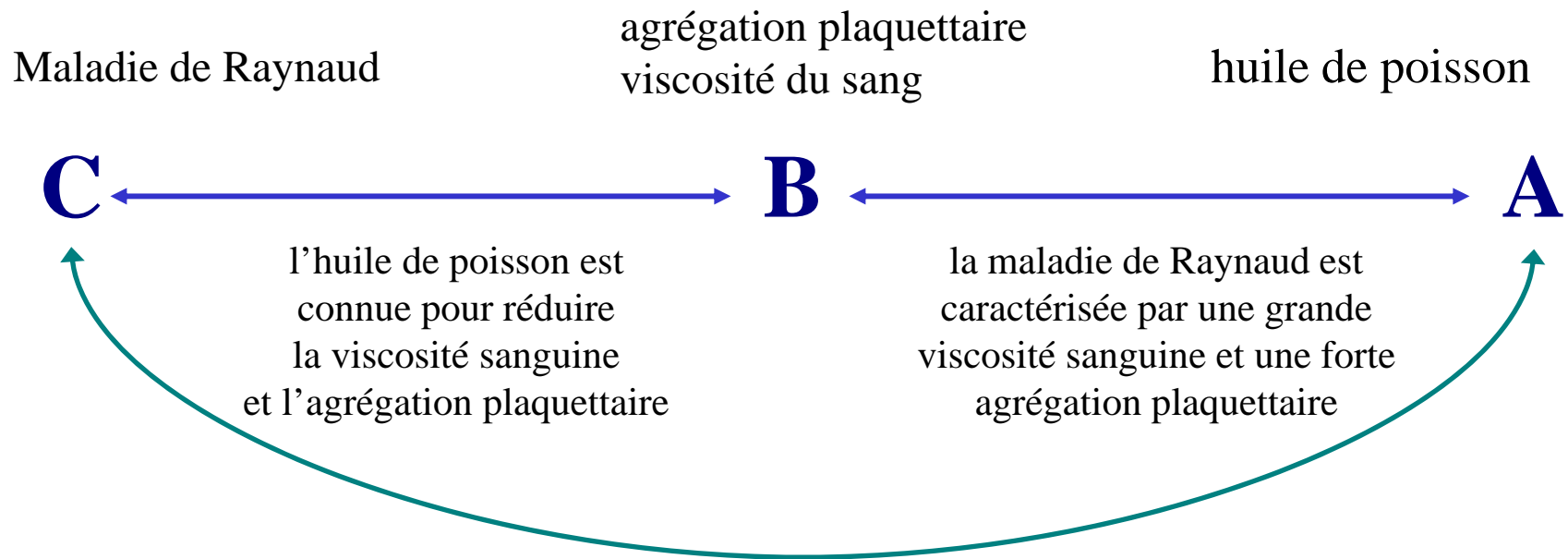

**Jusqu'en 1985, ces deux données n'étaient pas liées**

# KDD: Knowledge database discovery

- Use of AZASETRON for the treatment of Rosacea and pharmaceutical compositions  
WO2007138234 (A1)(2007-12-06)  
PIERRET Jean-Dominique [FR]; DOLFI Fabrizio [FR]; LOESCHE Christian [FR]; TREMEL Nadege [FR]  
GALDERMA RES & DEV [FR]
- Use of GRANISETRON for the treatment of sub-types of rosacea, and pharmaceutical compositions  
WO2007138232 (A2) (2007-12-06)  
PIERRET Jean-Dominique [FR]; DOLFI Fabrizio [FR]; LOESCHE Christian [FR]; TREMEL Nadege [FR]  
GALDERMA RES & DEV [FR]
- Method of treating inflammatory skin diseases using TROPISETRON, and pharmaceutical compositions thereof  
WO2007099069 (A1) (2007-09-07)  
TREMEL Nadege [FR]; PIERRET Jean-Dominique [FR]; DOLFI Fabrizio [FR]; LOESCHE Christian [FR]  
GALDERMA RES & DEV [FR]
- Treating inflammation with ONDANSETRON and pharmaceutical compositions comprised thereof  
US2007148197 (A1) (2007-06-28)  
DOLFI Fabrizio [FR]; TREMEL Nadege [FR]

PATENTE COMO FATOR DE INTELIGÊNCIA  
COMPETITIVA  
CASO TENOFOVIR

WANISE BARROSO

Brasília, 31 de julho de 2008.



*2º Seminário sobre  
Informação na Internet*  
*Conteúdos e Infodiversidade*



**GeCIC** 2008  
II Congresso Ibero-Americano  
de Gestão do Conhecimento  
e Inteligência Competitiva



**PROPRIEDADE  
INDUSTRIAL**

**INOVAÇÃO  
TECNOLÓGICA**

**INTELIGÊNCIA  
COMPETITIVA**

# CONSTITUIÇÃO FEDERAL

A Constituição Federal define a saúde como um direito de todos e um dever do Estado.

- Art. 196. A saúde é direito de todos e dever do Estado, garantido mediante políticas sociais e econômicas que visem à redução do risco de doença e de outros agravos e ao acesso universal e igualitário às ações e serviços para sua promoção, proteção e recuperação.

# Medicamentos Antiretrovirais Distribuídos pelo Ministério da Saúde

Medicamentos/ AIDS	Apresentação
ABACAVIR (ABC)	ABACAVIR (ABC) 300 mg*
	ABACAVIR (ABC) solução oral 20mg/ml*
AMPRENAVIR (APV)	AMPRENAVIR (APV) 150 mg*
	AMPRENAVIR (APV) solução oral 15mg/ml*
ATAZANAVIR (ATV)	ATAZANAVIR (ATV) 150 mg*
	ATAZANAVIR (ATV) 200 mg*
DIDANISINA (ddi)	DIDANISINA (ddi) 100 mg
	DIDANISINA (ddi) 25 mg
	DIDANISINA (ddi) pó para solução oral
EFAVIRENZ (EFV)	EFAVIRENZ (EFV) 600 mg*
	EFAVIRENZ (EFV) solução oral 30mg/ml*
ESTAVUDINA (d4T)	ESTAVUDINA (d4T) 30 mg
	ESTAVUDINA (d4T) 40 mg
	ESTAVUDINA (d4T) pó para solução oral
INDINAVIR (IDV)	INDINAVIR (IDV) 400 mg
LAMIVUDINA (3TC)	LAMIVUDINA (3TC) 150 mg
	LAMIVUDINA (3TC) solução oral 10mg/ml
LOPINAVIR/RITONAVIR (LPVTR)	LOPINAVIR/RITONAVIR (LPVTR) 133,33/33 mg*
	LOPINAVIR/RITONAVIR (LPVTR) solução oral 80mg/20 mg/ml*
NELFINAVIR (NFV)	NELFINAVIR (NFV) 250 mg*
	NELFINAVIR (NFV) pó para solução oral*
NEVIRAPINA (NVP)	NEVIRAPINA (NVP) 200 mg
	NEVIRAPINA (NVP) solução oral 10mg/ml
RITONAVIR (RTV)	RITONAVIR (RTV) 100mg
	RITONAVIR (RTV) solução oral 80mg/ml*
SAQUINAVIR (SQV)	SAQUINAVIR (SQV) 200 mg*
TENOFOVIR (TDF)	TENOFOVIR (TDF) 300 mg*
ZIDOVUDINA (AZT)	ZIDOVUDINA (AZT) 100 mg
	ZIDOVUDINA (AZT) 200mg/20 ml
	ZIDOVUDINA (AZT) 300mg + 3TC 150 mg
	ZIDOVUDINA (AZT) solução oral 10mg/ml

**80%** do orçamento do MS em medicamentos para AIDS destina-se à importação de medicamentos patenteados

# CUSTO MÉDIO ANUAL DA TERAPIA ANTI-RETROVIRAL POR PACIENTE/ANO (EM US\$), BRASIL, 2005

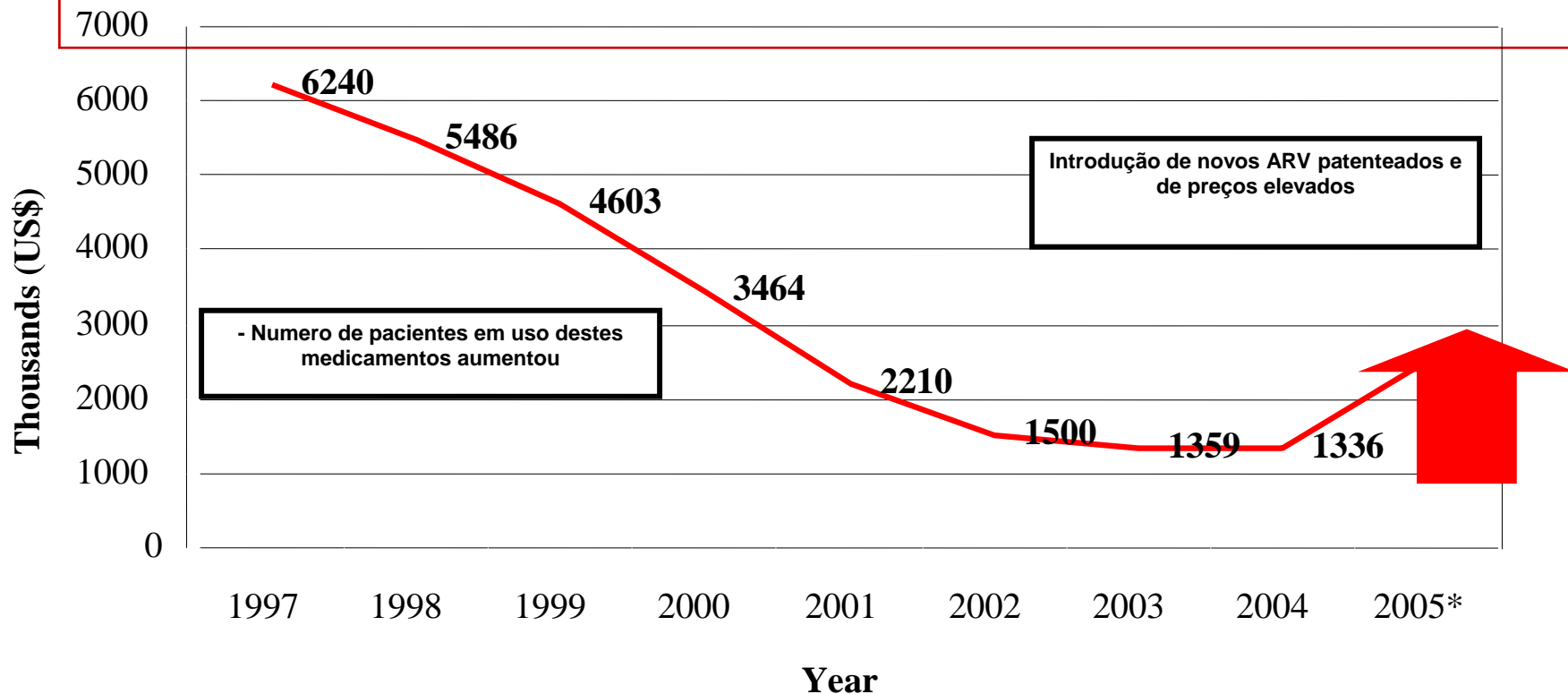

Fonte: Chequer, 3ª Conferência do IAS sobre a Patogênese e o tratamento do HIV (2005)

# LEI DA PROPRIEDADE INDUSTRIAL 9.279/9

- Brasil não concedia patente para medicamentos

**1996**

- Brasil passou a conceder patente para medicamentos

# Caso TENOFOVIR

# PREÇO – TENOFOVIR 300

mg

## LISTA DE ÍTENS DE COMPRA

Data	Qtde.	Preço Unit. R\$	Total R\$ (milhões)	Fornecedor	Fabricante
<b>19/06/2006</b>	<b>8.100.000</b>	<b>9,50</b>	<b>76,950</b>	United Medical	Sciens - United Medical Ltda
<b>30/04/2007</b>	<b>10.500.000</b>	<b>7,73</b>	<b>81,165</b>	United Medical	Gilead Sciences Inc
<b>25/02/2008</b>	<b>11.400.000</b>	<b>6,48</b>	<b>73,872</b>	United Medical	Gilead Sciences Inc

Fonte: <http://bpreco.saude.gov.br/bprefd/owa/consulta.inicio>

# LINHA DO TEMPO

Ano	Ações
1997	Depósito do pedido de patente tenofovir nos EUA
1998	Depósito do pedido de patente no BR e outros países
2001	Registro VIREAD (tenofovir) FDA US\$4.135,00 (R\$11.400,00)/paciente/ano
2003	Preço de fábrica US\$ 13,60 a unidade, mas o MS conseguiu por US\$ 9,04 o tratamento/dia (redução de 33,35% ).
2006	US\$ 4,24 o comprimido ou US\$ 1.547,60/paciente/ano
2007	US\$ 3,80 o comprimido ou US\$ 1.387,00 /paciente/ano
2008	US\$ 3,54 o comprimido ou US\$ 1.292,10/paciente/ano

# LINHA DO TEMPO - Ações

- 2002 – Primeiros testes com outras substancias :

Leandro, Lucienne, Wanise, Joachim, Eli, Luc

- 2004 – Estágio de 45 dias na Université Aix Marseille III
- 2005 – Subsídio ao exame de pedido de patente no INPI por Farmanguinhos
- 2006 – *Pre-Grant Opposition* ao pedido de patente na Índia
- 2006 - Subsídio ao exame de pedido de patente no INPI pela Fiocruz
- 2008 (Abril) – Exame do pedido de patente pelo INPI
- 2008 (Abril) – Solicitação de exame prioritário pelo MS ao INPI
- 2008 (Setembro) indeferimento da patente no Brasil

Université Aix-Marseille III

Farmanguinhos

Especialistas em Inteligência Competitiva

Especialistas em Propriedade Industrial

Especialistas em Síntese Orgânica

Engenheiros Químicos

Farmacêuticos

Químicos

- BRASIL –MS, PN DST/Aids, Fiocruz, Farmanguinhos, ONGs (ABIA, MSF)
- INDIA – ONG de Aids/MSF
- EUA – PubPat (ONG de Aids)
- CHINA – ONG de Aids/MSF

# PREÇO – TENOFOVIR 300 mg

## LISTA DE ÍTENS DE COMPRA

Data	Qtde.	Preço Unit.	Total (milhões) R\$	Fornecedor	Fabricante
19/06/2006	8.100.000	9,5000	76,950	United Medical	Sciens - United Medical Ltda
30/04/2007	10.500.000	7,7300	81,165	United Medical	Gilead Sciences Inc
25/02/2008	11.400.000	6,4800	73,872	United Medical	Gilead Sciences Inc

Fonte: <http://bpreco.saude.gov.br/bprefd/owa/consulta.inicio>

Publicação parecer do INPI – 08/04/2008

Resposta da Gilead ao parecer do INPI – 07/07/2008

Redução de 15% em julho 2008 – R\$ 11,08 milhões

**10 anos R\$110 milhões**

# ESTRATÉGIA

**PATENTE**

**LICENÇA  
COMPULSÓRIA**

**PEDIDO DE  
PATENTE**

**SUBSÍDIO  
AO EXAME**

**PATENTE**

**NULIDADE  
ADMINISTRATIVA  
OU JUDICIAL**

**LICENÇA  
COMPULSÓRIA**

**ANALISAR FALTA DE:**  
Novidade  
Atividade Inventiva  
Suficiência Descritiva

# 71 PEDIDOS DE PATENTE- TENOFOVIR

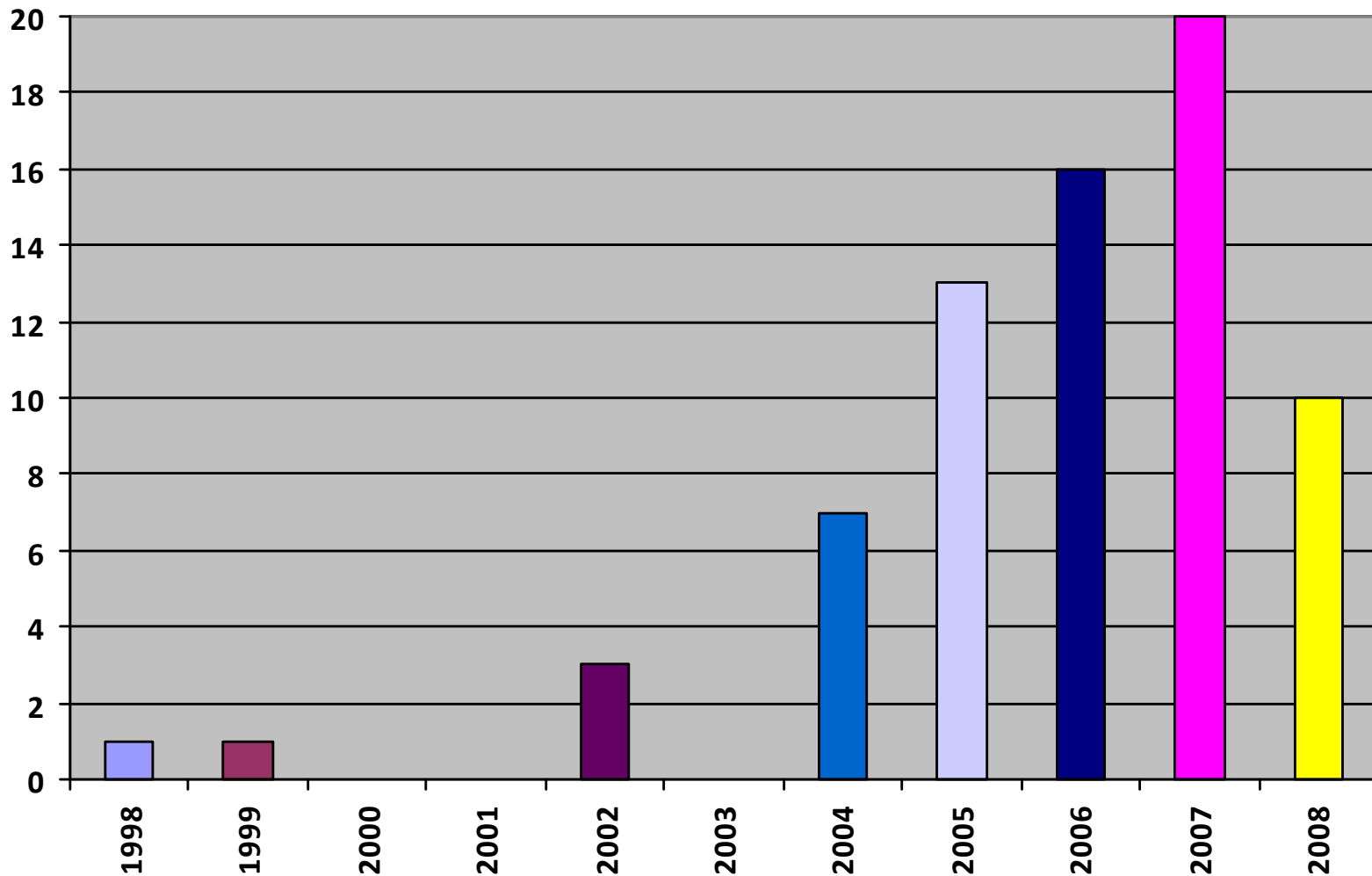

# PRINCIPAIS DEPOSITANTES DE PATENTES

(42)

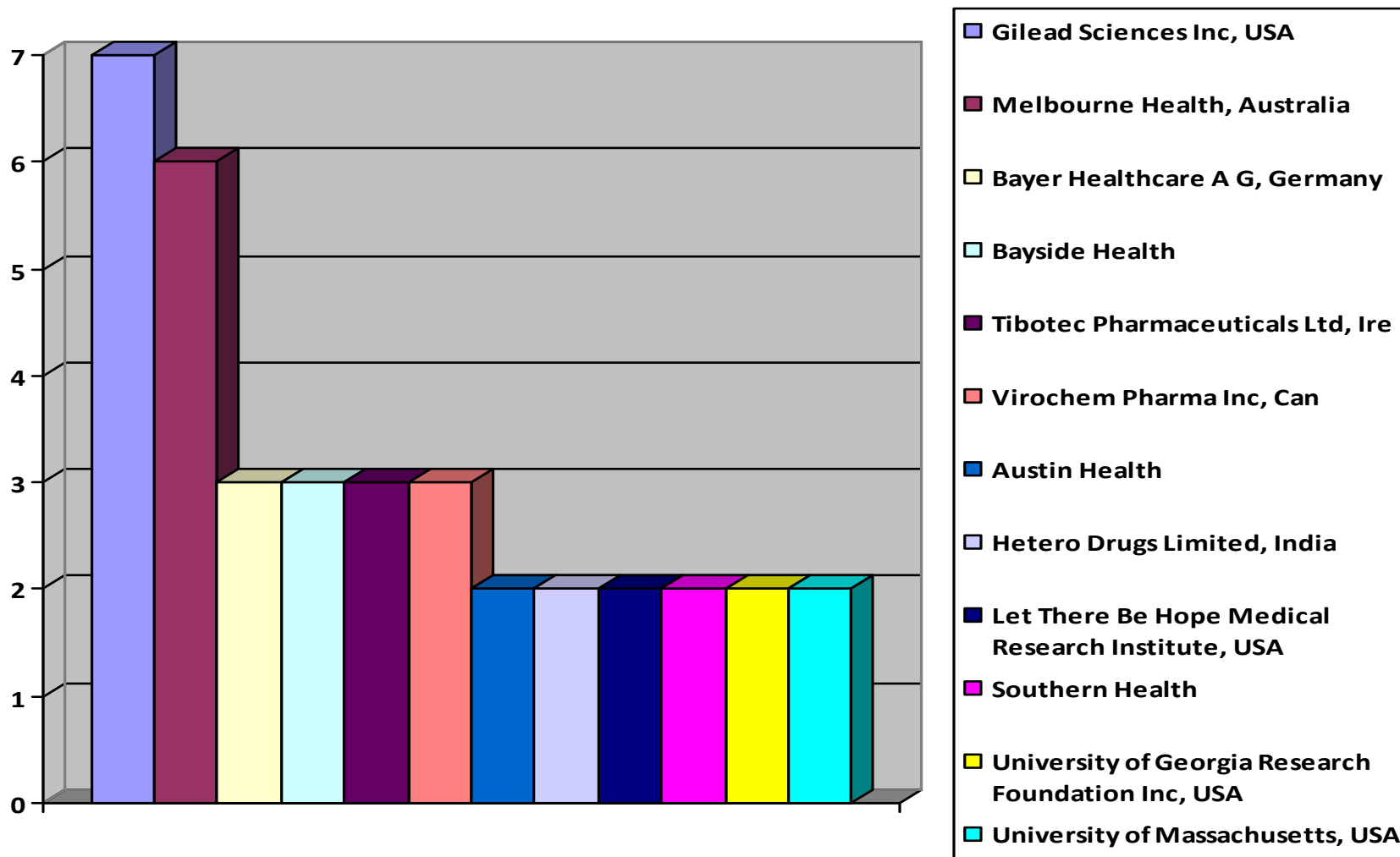

# ESTRATÉGIAS

## AÇÕES

MAPEAR

MONITORAR

PROSPECTAR

## ONDE?

Medicamentos/Kits

Patentes

Laboratórios

Acordos Internacionais

Legislação Nacional

- Projetos de lei
- Diretrizes de exame
- Resolução 132 - INPI

# REDES

## PRINCIPAIS REDES

- CONSENSO TERAPÊUTICO (Prescrição de novos medicamentos)
- ESTUDO DE SITUAÇÃO PATENTÁRIA
  - PATENTEADO ... Nulidade da patente
    - ... Licenciamento ... Voluntário
    - ... Compulsório
    - ... Desenvolvimento de novo medicamento
  - EM FASE DE EXAME ... Subsídio a exame
  - DOMÍNIO PÚBLICO ... Produção de Genérico
- LABORATÓRIO(S) OFICIAL e/ou NACIONAL
  - ... Produção de Princípio Ativo
  - ... Produção de medicamento

# Patent troll?



One of the winners of the 14 th concourse, 2010

Inovação na gestão publica federal  
organized by

***ENAP* - Escola Nacional de Administração Pública, Brasilia, Brasil**

Ravaschio, Juliana, Leandro Faria, et Luc Quoniam. 2010. O uso de patentes como fonte de informação em dissertações e teses de engenharia química: o caso da Unicamp. *Revista Digital de Biblioteconomia e Ciência da Informação* 7, no. 2 (Mars 1): 219-232. <http://polaris.bc.unicamp.br/seer/ojs/viewarticle.php?id=259>.



Obrigado pela atenção

<http://quoniam.info>

[mail@quoniam.info](mailto:mail@quoniam.info)